

# LPX300

# Industrial Imaging System

## Operator's Manual

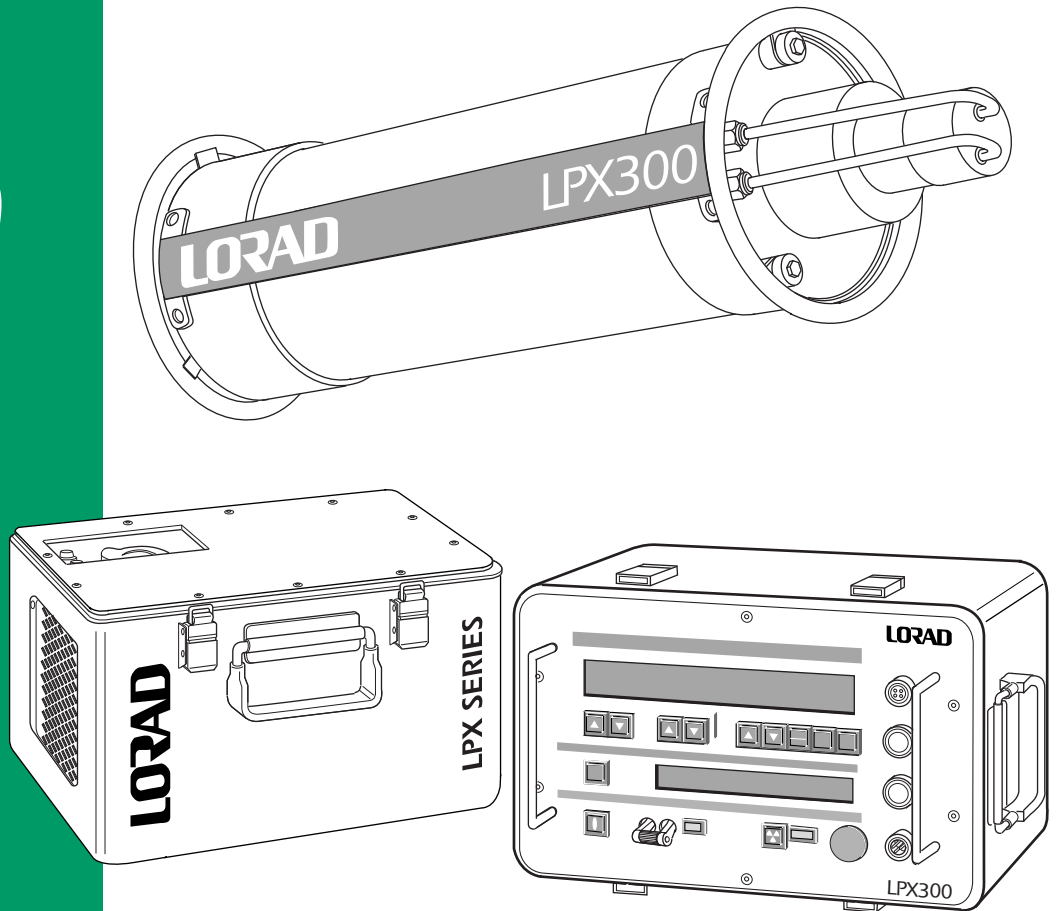

# LORAD

9-500-0260

**CAUTION: THIS EQUIPMENT PRODUCES  
X-RAYS WHEN ENERGIZED!**



**DO NOT OPERATE THIS EQUIPMENT WITHOUT  
FORMAL HARDWARE TRAINING FROM  
SPELLMAN HIGH VOLTAGE ELECTRONICS.  
ASNT LEVEL 3 RADIOGRAPHIC CERTIFICATION  
IS HIGHLY RECOMMENDED.**

**[WWW.SPELLMANHV.COM](http://WWW.SPELLMANHV.COM)**

Copyright © 2000, Spellman High Voltage Electronics Corporation. All Rights Reserved.  
This information contained in this publication is derived in part from proprietary and patent data. This information has been prepared for the express purpose of assisting operating and maintenance personnel in the efficient use of the model described herein, and publication of this information does not convey any right to reproduce it or to use it for any purpose other than in connection with installation, operation, and maintenance of the equipment described.

## COPYRIGHT NOTICE

This document is copyrighted by LORAD.  
No part of this document may be reproduced, transmitted,  
or copied without the express written permission of:

# **LORAD**

Spellman Valhalla 1 Commerce Park Valhalla, NY 10595  
Phone: +1 914 686-3600 Fax: +1 914 686-5424  
[www.spellmanhv.com](http://www.spellmanhv.com)

# **LPX-300 Industrial Imaging System Operator's Manual**

**Part Number 9-500-0260, Revision 2**

Copyright© 2002 by LORAD

All rights reserved.

**This Page Is Intentionally Blank**

## Contents

# Chapter 1

### **INTRODUCTION & GENERAL INFORMATION**

<b>INTRODUCTION</b> .....	<b>1-1</b>
<i>Intended Use</i> .....	1-1
<b>SYSTEM OVERVIEW</b> .....	<b>1-1</b>
<i>The Control Unit</i> .....	1-2
<i>The Tubehead</i> .....	1-2
<i>The Cooling Unit</i> <i>(liquid-cooled units only)</i> .....	1-2
<i>Legend - LPX-300 X-ray System</i> .....	1-3
<b>MANUAL OUTLINE</b> .....	<b>1-4</b>
<i>Chapter 1:</i> <i>Introduction &amp; General Information</i> .....	1-4
<i>Chapter 2:</i> <i>Preparation For Use and Shipment</i> .....	1-4
<i>Chapter 3:</i> <i>Installing the LPX-300</i> .....	1-4
<i>Chapter 4:</i> <i>LPX-300 X-ray Controls &amp; Indicators</i> .....	1-4
<i>Chapter 5:</i> <i>LPX-300 X-ray System Operation</i> .....	1-4
<i>Section 6:</i> <i>Routine Upkeep and Care</i> .....	1-4
<b>SAFETY SUMMARY</b> .....	<b>1-5</b>
<i>Radiation Hazard</i> .....	1-6
<i>Lethal Voltages</i> .....	1-6
<i>Badges</i> .....	1-6
<i>Radiation Protection</i> .....	1-6
<i>Radiation Monitoring</i> .....	1-6
<i>Warm-Up Procedures</i> .....	1-6
<i>Operation</i> .....	1-6
<i>Cooling Unit Operation</i> .....	1-6
<i>Care in Handling</i> .....	1-6

# LPX-300

Industrial Imaging System

---

## **PREPARATION FOR USE & SHIPMENT**

---

<b>UNPACKING INSTRUCTIONS</b> .....	<b>2-1</b>
<i>Reshipment Guidelines</i> .....	2-1
<i>Transporting the Unit</i> .....	2-2
<b>EQUIPMENT CHECKLISTS</b> .....	<b>2-3</b>
<i>Checklist - Tubehead</i> .....	2-3
<i>Checklist - Standard Equipment</i> .....	2-3
<i>Checklist - Optional Equipment</i> .....	2-3
<b>WARNINGS LABELS &amp;</b>	
<b>CONTROL NUMBERS</b> .....	<b>2-4</b>
<b>SPECIFICATIONS</b> .....	<b>2-5</b>
<i>Specifications - General System</i> .....	2-5
<i>Specifications - General Tubehead</i> .....	2-6
<i>Specifications - Optional Tubehead</i> .....	2-6
<i>Specifications - Control Unit</i> .....	2-7
<i>Specifications - Cooling Unit</i> .....	2-7
<b>PRE-OPERATIONAL</b>	

## **INSTALLING THE LPX-300 X-RAY SYSTEM**

---

<b>CHECKS &amp; INSPECTION</b> .....	<b>3-1</b>
<i>Check - Tubehead Gas Pressure</i> .....	3-1
<i>Check - Cooling Unit</i> .....	3-1
<i>Check - Control Unit</i> .....	3-1
<b>SYSTEM SET UP PROCEDURES</b> .....	<b>3-2</b>
<i>System Interconnections - Liquid Cooled</i> .....	3-2
<i>System Interconnections - Air Cooled</i> .....	3-3
<i>Connecting to Power</i> .....	3-4
<b>EXTERNAL</b>	
<b>INTERLOCK CONNECTIONS</b> .....	<b>3-4</b>

Chapter

2

Chapter

3

# Chapter

# 4

## **LPX-300 X-RAY CONTROLS & INDICATORS**

<b>INTRODUCTION .....</b>	<b>4-1</b>
<i>Overview - Control Unit .....</i>	<i>4-1</i>
<i>Legend - LPX-300 Control Unit .....</i>	<i>4-1</i>
<b>THE LIQUID</b>	
<b>CRYSTAL DISPLAY SCREENS .....</b>	<b>4-2</b>
<i>The Exposure Technique LCD Screen .....</i>	<i>4-2</i>
<i>The Message / Mode LCD Display Screen .....</i>	<i>4-3</i>
<b>FRONT PANEL</b>	
<b>CONTROLS AND INDICATORS .....</b>	<b>4-4</b>
<i>The MAINS Switch .....</i>	<i>4-4</i>
<i>The MAINS ON Indicator .....</i>	<i>4-4</i>
<i>The SAFETY Switch .....</i>	<i>4-4</i>
<i>The kV SET Controls .....</i>	<i>4-4</i>
<i>The mA SET Controls .....</i>	<i>4-4</i>
<i>The EXPOSURE SET Controls .....</i>	<i>4-5</i>
<i>The UNITS Control .....</i>	<i>4-5</i>
<i>The TIME Control .....</i>	<i>4-5</i>
<i>The RESET Control .....</i>	<i>4-5</i>
<i>The SCROLL Control .....</i>	<i>4-6</i>
<i>The X-RAY ON Control .....</i>	<i>4-6</i>
<i>The X-RAY Indicator .....</i>	<i>4-6</i>
<i>The X-RAY OFF Control .....</i>	<i>4-6</i>

# Chapter

# 5

## **LPX-300 SYSTEM OPERATION**

<b>INTRODUCTION .....</b>	<b>5-1</b>
<i>Pre-Operational Safety Precautions .....</i>	<i>5-1</i>
<b>X-RAY TUBE WARM UP .....</b>	<b>5-2</b>
<i>Autowarm Sequence : &gt; 30 Days .....</i>	<i>5-2</i>
<i>Autowarm Sequence : 7 - 30 Days .....</i>	<i>5-3</i>
<i>Autowarm Sequence : 16 Hrs. - 7 Days .....</i>	<i>5-3</i>
<i>Autowarm Sequence : 8 Hrs. - 16 Hrs. ....</i>	<i>5-4</i>
<i>Autowarm Sequence : 4 Hrs. - 8 Hrs. ....</i>	<i>5-4</i>
<b>OPERATION -</b>	
<b>LPX-300 X-RAY SYSTEM .....</b>	<b>5-5</b>
<i>Sequence of Operation .....</i>	<i>5-5</i>
<b>LPX-300 FAULT MESSAGES .....</b>	<b>5-7</b>
<b>X-RAY TUBE SEASONING .....</b>	<b>5-8</b>

## Chapter

# 6

### **LPX-300 ROUTINE UPKEEP & CARE**

---

<b>INTRODUCTION .....</b>	<b>6-1</b>
<b>INSPECTION CHECKLISTS .....</b>	<b>6-1</b>
<i>Tubehead Checklist .....</i>	<i>6-1</i>
<i>Control Unit Checklist .....</i>	<i>6-2</i>
<i>Cooling Unit Checklist .....</i>	<i>6-2</i>
<i>Interconnecting Cables &amp; Hose Checklist .....</i>	<i>6-2</i>
<b>CLEANING THE</b>	
<b>LPX-300 X-RAY UNIT .....</b>	<b>6-3</b>
<i>Required Cleaning Materials .....</i>	<i>6-3</i>
<i>Cleaning the X-Ray Unit .....</i>	<i>6-3</i>
<b>TUBEHEAD MAINTENANCE .....</b>	<b>6-4</b>
<i>Temperature Compensation .....</i>	<i>6-4</i>
<i>Re-Pressurizing the Tubehead .....</i>	<i>6-5</i>
<i>Re-Filling the Tubehead .....</i>	<i>6-6</i>
<i>Cleaning - Control Unit Air Filter .....</i>	<i>6-6</i>
<b>COOLING UNIT UPKEEP .....</b>	<b>6-7</b>
<i>Mixing &amp; Adding Coolant Solution .....</i>	<i>6-7</i>
<i>Cleaning - Cooling Unit Air Filter .....</i>	<i>6-7</i>
<i>Cleaning - Coolant Filter .....</i>	<i>6-8</i>



# Chapter 1:

## Introduction and General Information

### INTRODUCTION

This manual describes the LORAD LPX-300 Portable Industrial X-ray Unit and explains the procedures to properly set up, inspect, operate, and maintain this system.

#### Intended Use

The LPX-300 is designed to meet the needs of the commercial NDT user. The system is intended for, but not limited to, the inspection of materials for:

- ◆ defects
- ◆ inclusions
- ◆ cracks
- ◆ corrosion
- ◆ porosity

### SYSTEM OVERVIEW

The LPX-300 can generate x-ray potential up to 300 kilovolts (kV) and tube current up to 10 milliamperes (mA). The maximum allowable dissipation is 900 watts. Maximum tube current is limited automatically by the Control Unit to 10mA, or to a value that does not cause dissipation greater than 900 watts at a set kV level.

The system offers a 100% duty cycle and consists of the following assemblies:

- ◆ the Control Unit
- ◆ the Tube Head
- ◆ the Cooling Unit, (liquid cooled units only)
- ◆ the Electric Cooling Fan (air cooled units only)

These assemblies are described in detail next.

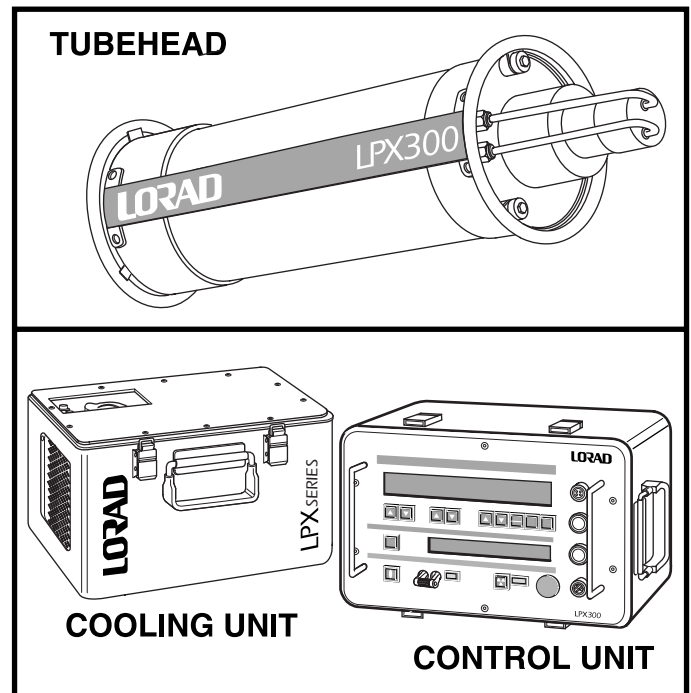

**Figure 1-1:**  
**The LPX-300 X-ray System**

# LPX-300

## Industrial Imaging System

---

### The Control Unit

The radiographer uses the Control Unit to set the radiographic exposure parameters, and to activate/deactivate x-ray emissions from the Tubehead. One hundred feet of cable is supplied with the system, which enables the Control Unit an operator to maintain a safe distance from the x-ray Tubehead during use.

The digital-based, microprocessor-regulated Control Unit houses all the system pushbutton operating controls, an exposure factor LCD Screen (for display of exposure factors), a Message LCD Screen (for display of operating mode and system messages), and the circuitry required to provide power to the Tubehead and Cooling Unit.

The Control Unit is enclosed in a metal container with a removable cover. A collapsible handle is attached to the cover to provide a means of transporting the Control Unit.

### The Tubehead

The Tubehead is a cylindrical aluminum shell assembly housing the x-ray tube, the high voltage power supply, and the filament supply. It is insulated with sulfur hexafluoride gas, pressurized to 50 psi @70°F. Power to operate the x-ray tube is supplied through a shielded cable that connects the Tubehead to the Control Unit. The x-ray tube is end grounded, with an exposed anode which contains a beryllium window approximately 2 inches from the anode end. Bolt on carrying handles are at each end of the Tubehead.

There are two Tubehead models available:

- ◆ Liquid-cooled
- ◆ Air-cooled

The liquid-cooled Tubehead uses a separate Cooling Unit to dissipate anode heat. These models have a length of twin hose attaching the Tubehead to the Cooling Unit. Air-cooled models have an electric cooling fan mounted at the anode end of the Tubehead. The fan is powered by an interconnecting cable from the Control Unit.

### The Cooling Unit (liquid-cooled units only)

The Cooling Unit dissipates heat generated at the anode of the x-ray tube. Liquid coolant from a self-contained reservoir is pumped through one side of a twin hose assembly, into the Tubehead. In the Tubehead, coolant flows through a cooling manifold, into the anode, and then back to the Cooling Unit through the second half of the twin hose assembly.

Once in the Cooling Unit, coolant passes through a flow switch that is electrically interlocked with the Control Unit, and then through a filter to screen out contaminants. From the filter, coolant flows through a forced air radiator, where conducted heat is dissipated, and then back into the reservoir.

An electric motor-driven fan and pump assembly circulates coolant and creates airflow through the radiator. Power is supplied via an interconnecting cable from the Control Unit. When properly connected to the system, the Cooling Unit is automatically activated by a switching circuit within the Control Unit.

### Legend - LPX-300 X-ray System

Use the following legend as a reference for parts identification.

- |                                   |  |
|-----------------------------------|--|
| 1. Exposure Technique LCD Display | 8. Lockout Keyswitch                   |
| 2. Message LCD Display            | 9. Tubehead Anode                      |
| 3. Power Connector                | 10. Tubehead Coolant Hose Fittings     |
| 4. Tubehead Connector             | 11. Tubehead Gas Pressure Gauge        |
| 5. Cooler Connector               | 12. Tubehead Cable Connector           |
| 6. Interlock Connector            | 13. Cooling Unit Reservoir Cap         |
| 7. Mains On/Off Switch            | 14. Cooling Unit Coolant Hose Fittings |
|                                   | 15. Cooling Unit Cable Connector       |

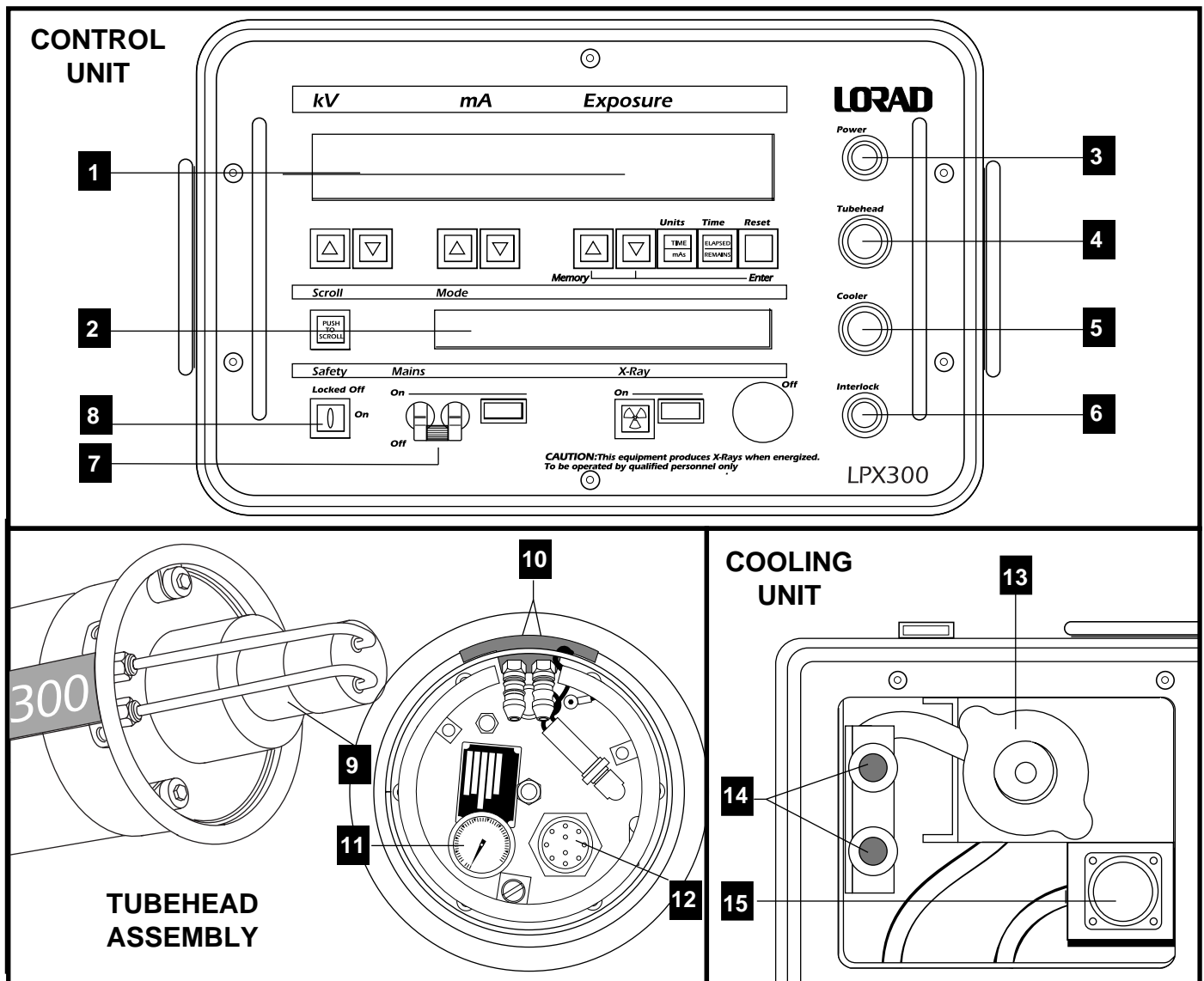

Figure 1-2:  
Legend - LPX-300

# LPX-300

## Industrial Imaging System

---

### MANUAL OUTLINE

This manual provides qualified radiographers and technicians with a means to logically inspect, operate, and maintain the LORAD LPX-300 Portable X-ray Unit. The following paragraphs describe the arrangement of this manual and the information contained in each section.

#### **Chapter 1: Introduction & General Information**

This section provides general information about the LPX-300. Included in this section is a safety summary.

#### **Chapter 2: Preparation For Use and Shipment**

In this chapter, the user is provided instructions for unpacking and reshipment, along with equipment checklists, and the basic specifications of for assembly. Also included in Chapter 2 are the locations of warning labels and I.D. tags.

#### **Chapter 3: Installing the LPX-300**

This chapter provides instructions on making the interconnections for both liquid cooled and air cooled units. Also includes is a description of possible external interlock connections.

#### **Chapter 4: LPX-300 X-ray Controls & Indicators**

Chapter 4 details the controls and indicators on the LPX-300 Control Unit. Refer to this chapter during use for operational details.

#### **Chapter 5: LPX-300 X-ray System Operation**

The warm up and operating instructions for the LPX-300 X-ray Unit are detailed in Chapter 5. Included are descriptions of error messages.

#### **Section 6: Routine Upkeep and Care**

This chapter covers preventive maintenance and care schedules for each assembly of the system. Included are procedures for pressurizing and refilling the Tubehead, cleaning the apparatus, and various general care practices.

### SAFETY SUMMARY

When properly installed, maintained, and operated, X-ray equipment can be used effectively and safely. If any component of this unit is incorrectly installed, and/or operated by unqualified personnel, or if the maintenance schedule is neglected, it is a potentially dangerous apparatus.

Before operating or performing any maintenance on the LPX-300, the user **MUST** have a thorough understanding of x-ray machinery, x-ray generation, x-ray potential, and x-ray control. The user **MUST** understand all hazards associated with x-ray generation.

Read this “Safety Summary” completely, and thoroughly understand its contents. Read all of the safety warnings, cautions, and notes throughout this manual prior to commencing any operating or maintenance procedures.

All operators and technicians **MUST** adhere to the following safety practices:

- ◆ Read and understand the x-ray protection warning published at the front of this manual.
- ◆ Read this manual in its entirety.
- ◆ Understand all procedures completely before operating the unit.
- ◆ Read thoroughly and understand completely all NOTE, CAUTION, and WARNING statements before beginning operation or maintenance procedures.

Use the following summary as a checklist to assure comprehension of the safety indicators.

**NOTE:**

*An essential operating procedure, condition, or statement, which must be observed to ensure proper understanding and operation of the system.*



**! CAUTION !**

**An operating or maintenance procedure, practice, condition, or statement, which, if not strictly observed, could result in damage to, or destruction of equipment.**



**! WARNING !**

**An operating or maintenance procedure, practice, condition, or statement, which, if not strictly observed, could result in injury to or death of personnel.**

# L PX-300

## Industrial Imaging System

---

### Radiation Hazard

This equipment generates X-radiation at levels that can be lethal. This unit must only be operated by personnel that are certified and experienced in industrial x-ray generation. All operators must also understand the characteristics of radiation and the associated dangers of exposure to primary, secondary, and residual sources of radiation.

### Lethal Voltages

High power radiation sources depend upon the generation of extremely high, yet well-protected voltages. Under no circumstances should the operator access the interior of the Tubehead. Also, under no circumstances should the operator access the interior of the Control Unit or the Cooling Unit except for the procedures outlined in Section 6 of this manual.

### Badges

All personnel who work around X-ray equipment must wear a functional exposure dosage indicator.

### Radiation Protection

X-ray equipment must be operated within properly designated protective barriers. Otherwise, personnel must not approach closer than 100 feet from the Tubehead, and in no cases cross the direct path of the primary beam.

### Radiation Monitoring

After installation, re-installation, transporting, performing maintenance, and during all radiographic operations not within a radiation enclosure, a radiation survey should be performed.

### Warm-Up Procedures

Explicit procedures are outlined for “running-up” high voltage with new equipment, equipment with a new tube, equipment that has been inactive for a period of time, and for daily use. These procedures must be strictly followed at all times.

### Operation

Equipment must be operated at correct source voltage and frequency, and must never be left running unattended. The gas pressure in the Tubehead must be checked to ensure it is within allowable limits before operating the unit. Never operate this apparatus if output voltage/current is unstable.

### Cooling Unit Operation

Regularly check the coolant solution in the Cooling Unit to ensure:

- ◆ the coolant level is within specification
- ◆ the pump circulates the coolant properly
- ◆ the fittings, hoses, and coolant reservoir do not leak

Always allow the Cooling Unit, or the fan on air-cooled units, to run approximately 5 minutes after completion of x-ray generation.

### Care in Handling

Extreme care must be taken when handling this x-ray apparatus. Exercise caution when packing, unpacking, shipping, and while performing maintenance. Remember, the X-ray tube is durable but breakable: be sure to store and ship it in the upright position.

## Chapter 2:

### Preparation for Use and Shipment

#### UNPACKING INSTRUCTIONS

The LPX-300 X-ray Unit is shipped in a single wooden container. To gain access to the unit, perform the following:

- ◆ Remove the top cover from the crate.
- ◆ Carefully lift each component from the container.
- ◆ Perform a thorough visual inspection on each component.

If damage to any component has occurred, immediately contact the carrier. Keep all damaged containers until the carrier completes an inspection by the carrier. If it is necessary to re-package and ship the unit, follow the instructions outlined under “Reshipment Guidelines”.

#### Reshipment Guidelines

In the event that the LPX-300 X-ray Unit must be transported or shipped, use the original wooden container and packaging material whenever possible. If the original shipping material is not available, comply with the following re-packing guidelines.

1. Construct a wooden shipping carton for the Tubehead Assembly similar to the one in Figure 2-1. Build the carton so that the top can be completely removed to facilitate packing and unpacking.
2. Cushion the Tubehead with 3" of shock absorbent, foam type, packing material (MINIMUM). This material MUST surround the assembly on all sides, including above and below the Tubehead.
3. Affix supporting legs to the bottom of the carton. Make sure the legs extend between 7 and 10 inches from the edges as shown in Figure 2-1.

4. Pack the Control Unit in a container rated for 60 lbs. Surround the Control Unit with a MINIMUM of 2" of shock absorbent packing material (sheet or loose type), including the top and bottom.
5. Pack the Cooling Unit in the same manner as the Control Unit.



#### **! WARNING !**

**The coolant solution is a flammable substance and must be drained from the Cooling Unit's reservoir before it can be shipped.**

# LPX-300

## Industrial Imaging System

### Transporting the Unit

When transporting by commercial carrier (i.e., truck, rail, etc.), select the shipping method and carrier on the basis of safe shipment, especially when shipping the fragile Tubehead Assembly. Distinctly mark the Tubehead carton on all sides with labeling which provides the carrier the following information:

- ◆ Contents contains fragile glass instrumentation
- ◆ Container is to be shipped in the upright position only

Customarily, the Tubehead is shipped via air, generally avoiding ground transportation if possible. When shipping via air, affix an additional label to the carton stating the following:

**“Sulfur hexafluoride, non-flammable gas is present in limited quantities in one or more packages of this shipment. This is to certify that the above mentioned materials are properly classified, described, packaged, marked, and labeled, and are in proper condition for transportation according to the applicable regulations of the U.S. Department of Transportation.”**

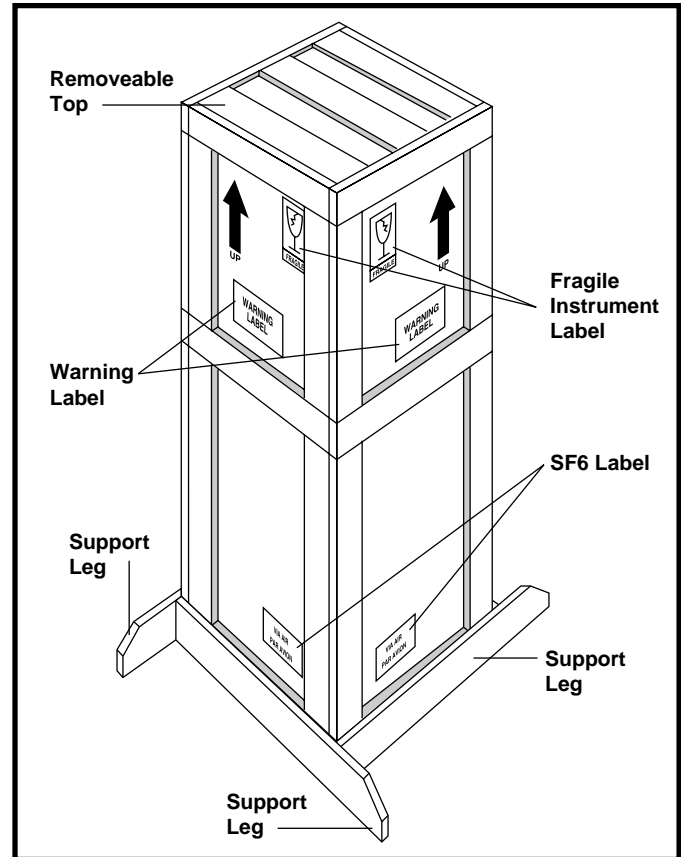

**Figure 2-1:**  
*Tubehead Shipping Container*



### EQUIPMENT CHECKLISTS

The following checklists outline the standard and optional equipment of the LPX-300 X-ray Unit. After unpacking the unit, and completing a thorough visual inspection, compare each item with this list to assure completeness.

Note that several Tubehead models are available. Verify that the Tubehead shipped with your unit matches the model that was originally ordered.

#### Checklist - Tubehead

- Assembly, Tubehead\* \_\_\_\_\_ 3-000-3192  
Air Cooled Unit; 40° x 60° cone  
1.5mm Focal Spot 1mm Beryllium Window
- Assembly, Tubehead \_\_\_\_\_ 3-000-3191  
Liquid Cooled; 40° x 60° cone  
1.5mm Focal Spot 1mm Beryllium Window

\* All Air Cooled Units are equipped with Fan Power Cable (p/n: 1-040A-0355). The liquid Cooling Unit is not equipped with this cable.

#### Checklist - Standard Equipment

- Control Unit, Digital (1) \_\_\_\_\_ 3-000-3190
- Cooling Unit Assy. (1) \_\_\_\_\_ 3-000-0737  
(Liquid Cooled Units Only)
- Power Cable Assy. (1) \_\_\_\_\_ 1-040-0825  
(3 Pin Connector, 25ft.)
- Control Cable Assy. (1) \_\_\_\_\_ 1-040-0824  
(14 Pin Connector, 100ft.)
- Cooler Power Cable (1) \_\_\_\_\_ 1-040-0823  
(Liquid Cooled Units Only, 8 Pin Connector, 50ft.)
- Power Cable, Fan (1) \_\_\_\_\_ 1-040-0355  
(Air Cooled Units Only, 100ft.)
- Interlock Jumper (1) \_\_\_\_\_ 1-040-0840  
(Jumper)
- Safety Switch Key (2) \_\_\_\_\_ 2-230-6201
- Interlock Connector (1) \_\_\_\_\_ 1-600-3660  
(Mating Connector)
- Cooling Hose (1) \_\_\_\_\_ 3-000-0742  
(Liquid Cooled Units Only, 50ft.)
- Carrying Case (1) \_\_\_\_\_ 3-630-0130

#### Checklist - Optional Equipment

- X-Ray Tubehead Stand \_\_\_\_\_ 3-000-3193
- Kit, Tubehead Re-charge \_\_\_\_\_ 9-200-0102
- Laser Pointer \_\_\_\_\_ 3-000-0792
- Laser Pointer Adapter \_\_\_\_\_ 9-200-0448
- Power Cable Assembly (1) \_\_\_\_\_ 1-040-0871  
(3 Pin Connector, 100ft)

# LPX-300

## Industrial Imaging System

### WARNINGS LABELS & CONTROL NUMBERS

Each assembly of the LPX-300 X-ray System is equipped with an I.D. tag (Control Tag) providing the serial number, description, and part number. This data is used for identification, if warranty or service information is needed, and will be requested when contacting LORAD regarding the apparatus.

Attached to the Control Unit and Tubehead are warning labels. Figure 2-2 illustrates the location of the I.D. tags and warning labels for each assembly of the LPX-300.

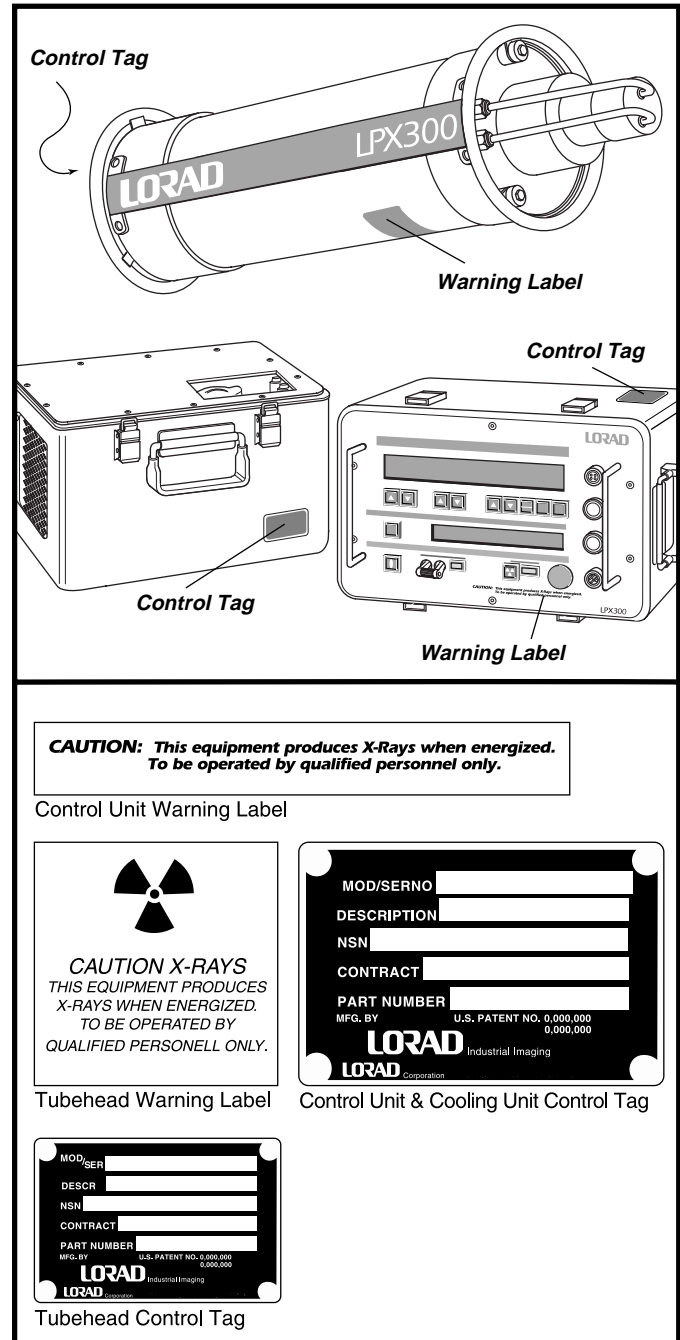

**Figure 2-2:**  
**Location of Warning Labels and Control Tags**

### SPECIFICATIONS

The following tables illustrate the physical, operational, and environmental specifications for each component of the LPX-300 System. Conformance with these specifications ensures maximum system performance, and reduces the chances of mechanical breakdown and personnel hazard.

#### Specifications - General System

The following outlines the general operating and environmental limits of the LPX-300 System.

- Line Voltage \* \_\_\_\_\_ 100 to 130VAC, 50/60 Hz, 20 amps (maximum); or 200 to 250VAC, 50/60 Hz, 15 amps (maximum)
- Operating Potential \_\_\_\_\_ 10kV to 300kV @ 0.1 to 10.0 mA, 900 Watts maximum
- Duty Cycle \_\_\_\_\_ 100%

- Operating Temperature Range \_\_\_\_\_ -30°F to 120°F (Ambient)  
-34°C to 49°C (Ambient)
- Humidity \_\_\_\_\_ 0 to 100% relative humidity
- Stabilization \_\_\_\_\_ kV and mA remain within 1% of set levels. Line voltage varied from 100-130/200-250 VAC.
- Storage Temperature Range \_\_\_\_\_ -65°F to 160°F (-54°C to 71°C)

\* Line voltage selection is automatic. The system is operable from either line voltage range without any switch or jumper configuration.

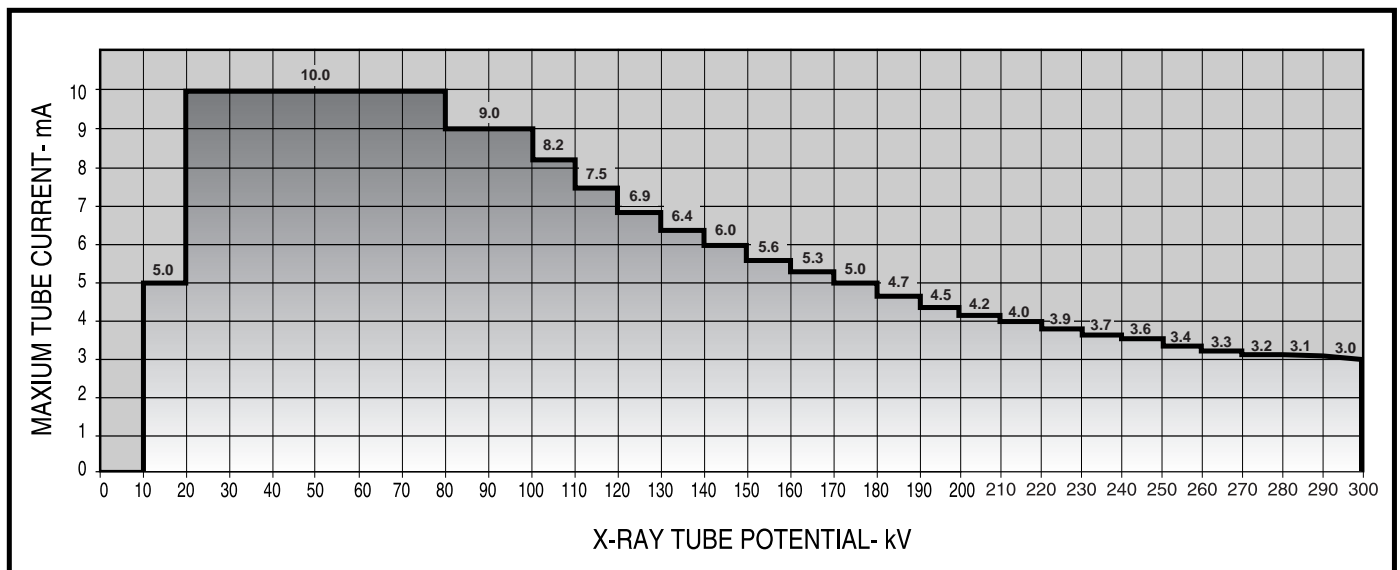

Figure 2-3:  
LPX-300 Maximum Tube Current

# LPX-300

## Industrial Imaging System

### Specifications - General Tubehead

The following outlines the general operating specifications of the Tubehead Assembly.

- Anode Cooling System \_\_\_\_\_ Recirculating Liquid Cooling unit or Fan Forced Air
- Radiation Output \_\_\_\_\_ 33R/minute @300kV, 3.0mA @ 50cm through 0.5 in. of Aluminum
- Leakage Radiation \_\_\_\_\_ 0.8 R / hr
- Tube Pressure Sense \_\_\_\_\_ Monitors pressure of the SF6 gas within the Tubehead. Shuts unit down if pressure falls below 25 psi.
- Anode Thermal Sense \_\_\_\_\_ Monitors temperature of the X-ray Tube Anode. Shuts down unit if Anode temperature rises above 220°F.
- Pressure Relief Valve \_\_\_\_\_ Automatically releases SF6 gas from Tubehead if pressure rises between 75 - 80 psi.
- Pressure Gauge \_\_\_\_\_ Displays SF6 gas pressure within Tubehead. Used in conjunction with Temperature Compensation chart to visually inspect Tubehead pressure.

### Specifications - Optional Tubehead

The information that follows furnishes the specifications for several available Tubehead assemblies. Figure 2-3 illustrates the direction of the X-ray beam for the 40° x 60° cone model.

- Tubehead 40° x 60° Cone \_\_ Air or liquid cooled models; 1.5mm Focal spots; 1mm beryllium window

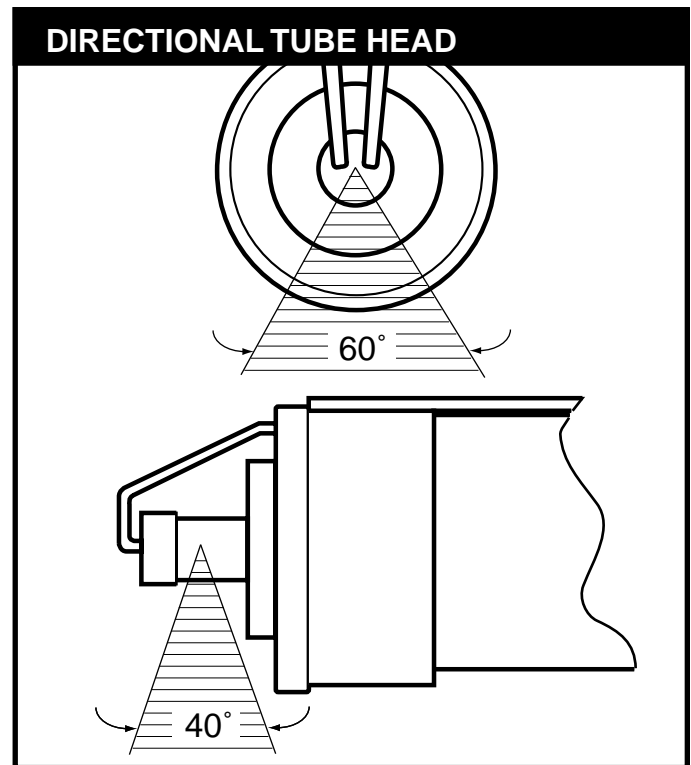

**Figure 2-4:**  
**X-ray Beam Path**

### Specifications - Control Unit

Below are the physical and operating specifications of the Control Unit. Included are the physical dimensions, and the operating indicators and controls. The controls are explained in detail in Section 4 of this manual.

- kV Control \_\_\_\_\_ Pushbutton switches set kV level between 0kV to 300kV in 1kV increments
- kV Indicator \_\_\_\_\_ LCD Readout on upper display
- mA Control \_\_\_\_\_ Pushbutton switches set mA level between 0 and maximum 10.0 mA in 0.1 mA increments (Control Unit automatically limits the mA so that 900 watt maximum is not exceeded)
- mA Indicator \_\_\_\_\_ LCD Readout on upper display
- X-ray ON Switch \_\_\_\_\_ Pushbutton switch with radiation symbol. Activates x-ray generation
- X-ray OFF Switch \_\_\_\_\_ Red mushroom type switch terminates x-ray generation. May be depressed anytime while x-rays are being generated.
- Key Lock Safety Switch \_\_\_\_\_ LOCKED OFF position prevents x-ray generation; ON position enables X-RAY ON switch
- Exposure Timer \_\_\_\_\_ LCD readout on upper display
- Weight \_\_\_\_\_ 35 lbs. (approximate)
- Dimensions \_\_\_\_\_ 12" W x 18" L x 12" H
- Power ON Indicator \_\_\_\_\_ Green LED array on front panel
- X-ray ON Indicator \_\_\_\_\_ Red LED array on front panel
- Interlock Connector \_\_\_\_\_ Pins A and B used for enclosure door switches which must be closed to enable the X-RAY ON switch. Pins C and D used for external warning devices, pins E and F used with optional prewarn/warning systems.

### Specifications - Cooling Unit

Below are the operating and physical specifications of the Cooling Unit.

- Dimensions \_\_\_\_\_ 12" H x 15" W x 14" L
- Weight \_\_\_\_\_ 55 lbs (approximate)
- Coolant Solution \_\_\_\_\_ 14 parts methyl alcohol, 7 parts distilled water, 1 part soluble oil (Chevron Soluble "B")
- Coolant Flow \_\_\_\_\_ 0.5 gallons per minute @ 50 foot head.
- Cooling Unit Connections \_ Self sealing quick disconnects.

# ***LPX-300***

*Industrial Imaging System*

---

**THIS PAGE IS INTENTIONALLY BLANK**

## Chapter 3:

### Installing the LPX-300 X-ray System

#### PRE-OPERATIONAL CHECKS & INSPECTION

The following paragraphs outline the steps to properly check and inspect the LPX-300 X-ray unit. Perform these procedures before setting up the system to ensure integrity.

##### Check - Tubehead Gas Pressure

This check verifies that the gas pressure inside the Tubehead assembly is within limits. Note that Tubehead gas pressure normally varies 1 psi for every 7°F increase or decrease in ambient air temperature.



**! CAUTION !**  
**DO NOT operate this unit if Tubehead Pressure is below 50 psi at 70°F or damage to the Tubehead may occur.**

1. Check the Tubehead gas pressure gauge and verify that the gas pressure is within acceptable limits for the ambient temperature (see Figure 6-2).
2. If the gauge indicates Tubehead gas pressure below the acceptable limit, but greater than 5 psi, perform the procedures for “Pressurizing the Tubehead” (refer to Section 6).
3. If Tubehead gas pressure is below 5 psi at 70°F, purge the Tubehead of all remaining gas, then perform the procedures for “Refilling the Tubehead” (see Section 6).

##### Check - Cooling Unit

This check verifies the integrity of the Cooling Unit (liquid cooled tubeheads only).

1. Inspect the twin hose assembly and hose connections for damage. The connector couplings must be firmly attached to the hose, and the hose must be free of punctures, frays, or dry rot.
2. Remove the Radiator cap on the Cooling Unit and check that the coolant level is within 1/2" from the top of the reservoir. Add coolant solution at this time if necessary (refer to Section 6).

##### Check - Control Unit

This check verifies the integrity of the Control Unit.

1. Remove the top cover from the Control Unit and perform a thorough visual inspection for damage.
2. Check the four connectors along the right side of the front panel for foreign material and signs of corrosion.
3. Inspect the front panel controls for missing or broken switches and displays.

# LPX-300

## Industrial Imaging System

### SYSTEM SET UP PROCEDURES

The procedures below describe the set up procedures for both LPX-300 configurations; liquid-cooled units, and air-cooled units. Use Figure 3-1 (liquid-cooled), or Figure 3-2 (air-cooled) as a reference while making the necessary system connections.

#### System Interconnections - Liquid Cooled

The following details the connections for setting up a liquid cooled LPX-300 X-ray System.



#### ! WARNING !

**All cables MUST be connected to their appropriate connectors on the Control Unit, Cooling Unit, and Tubehead before applying power to the system.**

1. Connect the twin hose assembly between the Tubehead and the Cooling Unit:
  - ◆ Attach the two angled couplings to the fittings on the back of the Tubehead.
  - ◆ Attached the couplings on the opposite end to the female fittings on the Cooling Unit.

#### NOTE:

*There is no designated left or right side to the twin hose assembly. If each coupling is properly seated, coolant flow through the Tubehead will be achieved.*

2. Install the Cooling Unit power cable:
  - ◆ Connect the male end of the power cable to the connector labeled “Cooler” on the Control Unit.
  - ◆ Connect the female end of the power cable to the connector on the Cooling Unit.
3. Install the Tubehead Control cable:
  - ◆ Connect the male end of the Control cable to the connector labeled “Tubehead” on the Control Unit.
  - ◆ Connect the female end of the Control cable to the connector on the Tubehead base plate.
4. Install the line power cable:
  - ◆ Connect the female end of the line power cable to the connector labeled “Power” on the Control Unit.
  - ◆ Connect the “plug” end of the line power cable to the AC voltage source (see Connecting to Power instructions later in this section).

5. Make the External Interlock connection:
  - ◆ If available, connect the Interlock cable to the connector labeled “Interlock” on the Control Unit (see External Interlock instructions later in this section).
  - ◆ Connect the “jumper” (supplied) to the connector labeled “Interlock” on the Control Unit for units that do not employ an external interlock system.

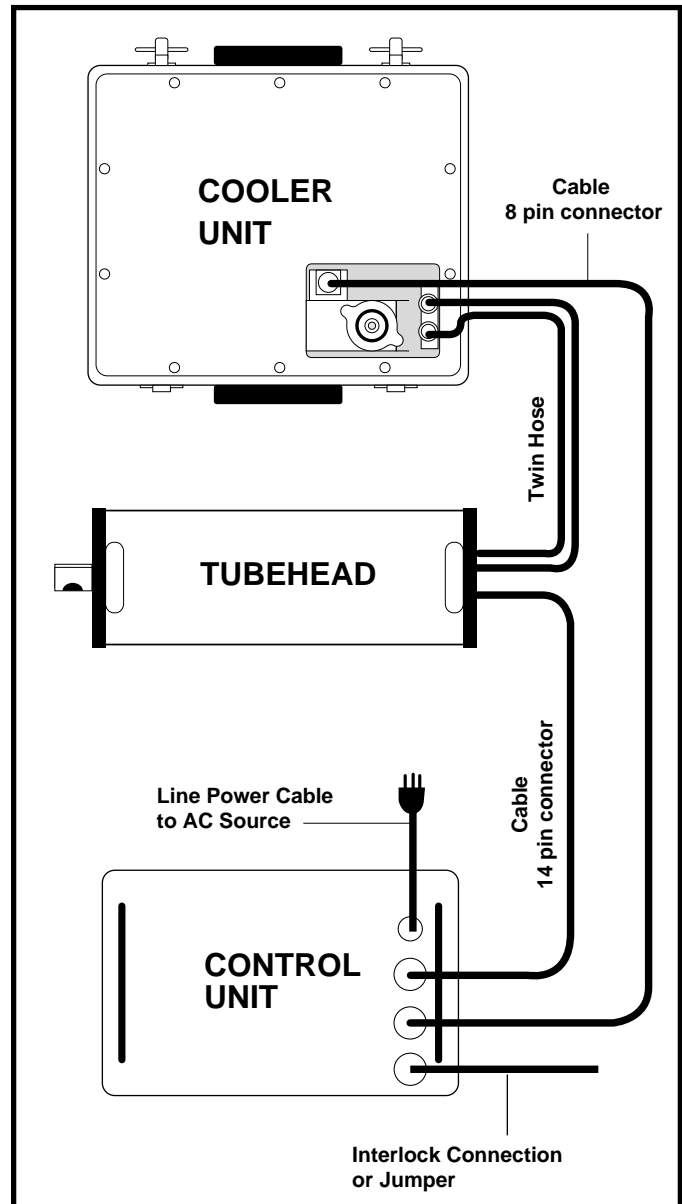

**Figure 3-1:**  
**LPX-300 Set Up (Liquid Cooled)**



### System Interconnections - Air Cooled

The following details the connections for setting up a liquid cooled LPX-300 X-ray System.



**! WARNING !**  
**All cables MUST be connected to their appropriate connectors on the Control Unit, Cooling Unit, and Tubehead before applying power to the system.**

1. Install the Cooling Fan power cable:
  - ◆ Connect the male end of the power cable to the connector labeled “Cooler” on the Control Unit.
  - ◆ Connect the female end of the power cable to the connector on the Tubehead base plate.
2. Install the Tubehead Control cable:
  - ◆ Connect the male end of the Control cable to the connector labeled “Tubehead” on the Control Unit.
  - ◆ Connect the female end of the Control cable to the connector on the Tubehead base plate.
3. Install the line power cable:
  - ◆ Connect the female end of the line power cable to the connector labeled “Power” on the Control Unit.
  - ◆ Connect the “plug” end of the line power cable to the AC voltage source (see Connecting to Power instructions later in this section).
4. Make the External Interlock connection:
  - ◆ If available, connect the Interlock cable to the connector labeled “Interlock” on the Control Unit (see External Interlock instructions later in this section).
  - ◆ Connect the “jumper” (supplied) to the connector labeled “Interlock” on the Control Unit for units that do not employ an external interlock system.

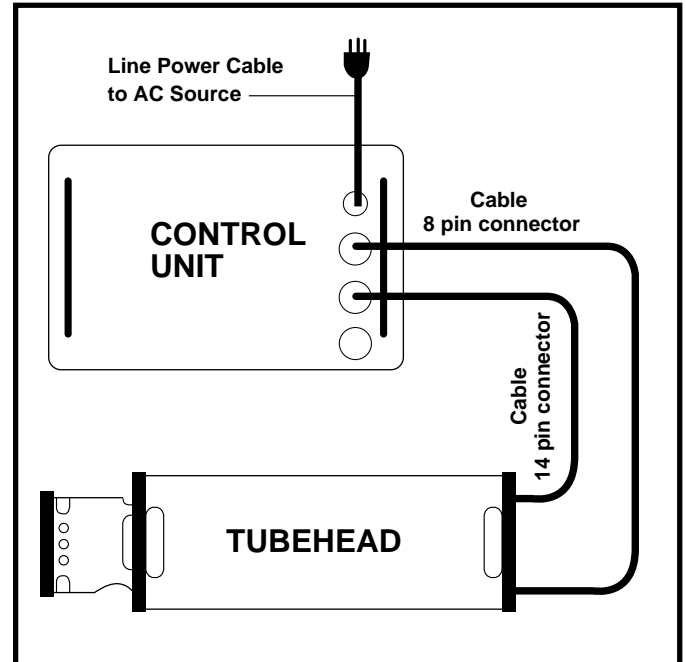

**Figure 3-2:**  
**LPX-300 Set Up (Air Cooled)**

# LPX-300

## Industrial Imaging System

### Connecting to Power

Note that the AC voltage source **MUST** be rated as either:

- ◆ 120 VAC, 20 amps, 50/60 Hz
- ◆ 230 VAC, 15 amps, 50/60Hz

Line voltage selection is automatic. For 220V input application, remove the male plug on the supplied power cord and replace it with one that fits the local AC receptacle, or an adapter cable can be locally manufactured. See Figure 3-3 for the correct plug termination.

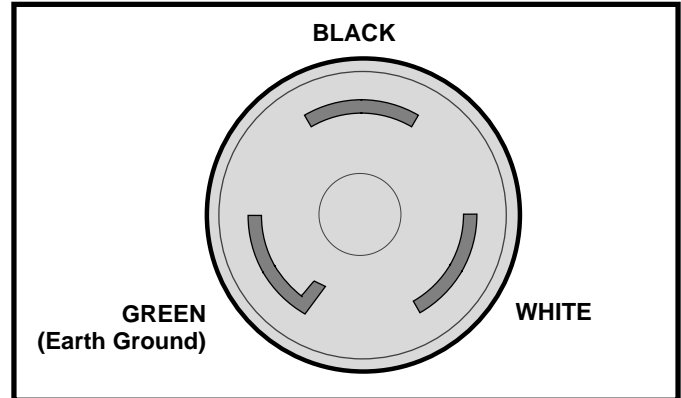

Figure 3-3:  
220 Volt Plug Termination

### EXTERNAL INTERLOCK CONNECTIONS

The INTERLOCK connector on the front panel of the Control Unit enables interconnection of x-ray enclosure doors and/or external warning devices with the internal safety interlock circuitry of the system. Figure 3-4 illustrates the two circuits provided for this purpose.

Pins "A" and "B" are used to connect enclosure door switches. When pins A and B are properly connected, x-ray generation is possible only when the enclosure doors housing the Tubehead are shut. Note that pins "A" and "B" of the INTERLOCK connector must form a closed circuit to operate the X-ray unit. If no external switch interlocks are incorporated, a jumper (provided) must be installed across pins "A" and "B" to form this closed circuit.

Pins "C" and "D" provide a switch closure to operate warning devices such as lights, sirens, or other types of external warning signals. These signals warn all personnel that x-rays are being generated.

Pins E and F are for use with optional LORAD pre-warning/warning devices.



**! WARNING !**  
**Voltage is present at pins "A" and "B" of the INTERLOCK when the unit is powered up. Ensure power is OFF before making any external connections or while installing the jumper.**

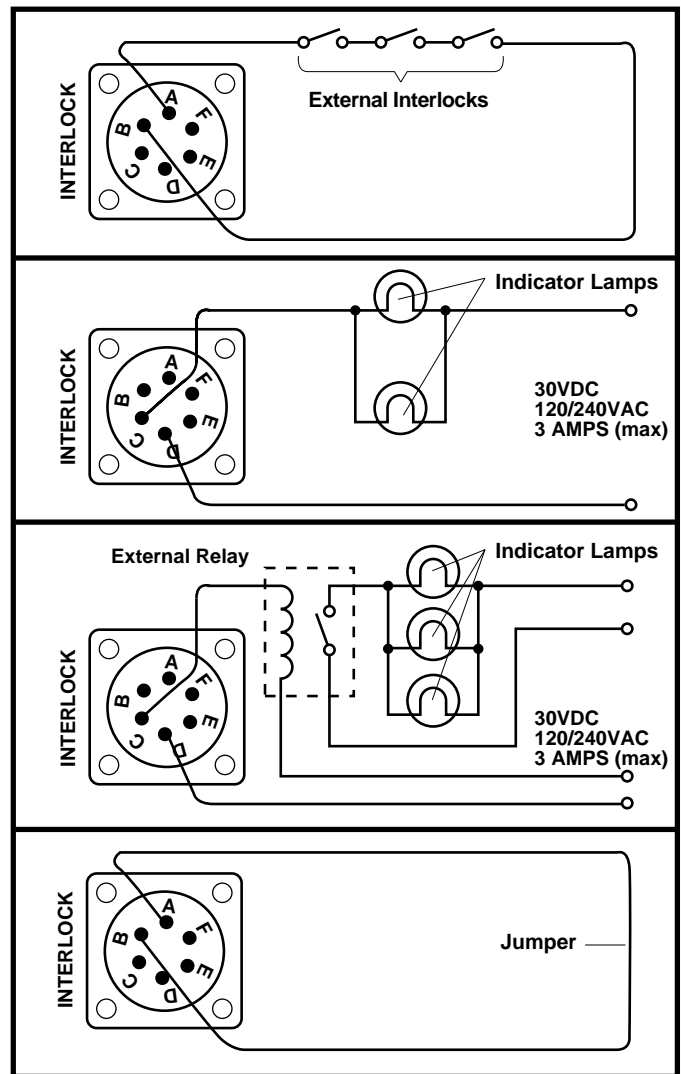

Figure 3-4:  
External Interlock Connections

# Chapter 4:

## LPX-300 X-ray Controls and Indicators

### INTRODUCTION

The following paragraphs describe the controls and switches on the control panel of the LPX-300 Control Unit. The functions and use of these controls must be thoroughly understood before operating the x-ray unit.

### Overview - Control Unit

The Control Unit's control panel is comprised of:

- ◆ 2 liquid crystal display (LCD) screens
- ◆ exposure parameter pushbutton control switches
- ◆ a Mains power circuit breaker
- ◆ LED indicators

Military type connectors, along the right side of the panel, are used to connect the input power cord and the system's interconnecting control cables and hoses.

### Legend - LPX-300 Control Unit

Use the following legend as a reference for parts identification (refer to Figure 4-1).

1. Exposure Technique LCD Display Screen
2. Message / Mode LCD Display Screen
3. Mains ON/OFF Circuit Breaker
4. Mains LED Indicator
5. Safety Key Lockout Switch
6. kV UP/DOWN Pushbuttons
7. mA UP/DOWN Pushbuttons
8. EXPOSURE (Time/mAs) UP/DOWN Pushbuttons
9. UNITS Select (Time/mAs) Pushbutton
10. TIME Counter Select Pushbutton
11. RESET Pushbutton
12. SCROLL Control
13. X-RAY ON Pushbutton
14. X-RAY OFF Pushbutton

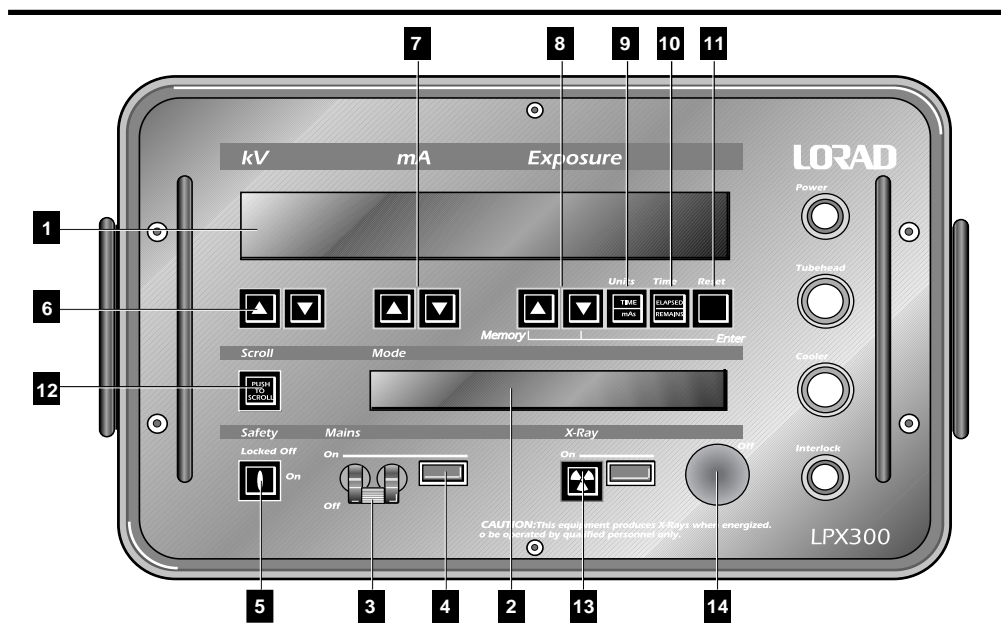

Figure 4-1:  
Legend - LPX-300 Control Panel

### THE LIQUID CRYSTAL DISPLAY SCREENS

The LPX-300 Control Unit incorporates two LCD Display screens:

- ◆ The Exposure Technique LCD
- ◆ The Message / Mode LCD

The following paragraphs describe both LCD screens, and the information they provide the user.

#### The Exposure Technique LCD Screen

The Exposure Technique LCD (large top screen) displays two rows of exposure parameters:

- ◆ the set techniques (top row)
- ◆ the operating levels (bottom row)

The top row shows the set exposure kV (left side), the mA (center), and the exposure duration (right side). The exposure duration displays in minutes and seconds or in mAs, depending on the selected TIME mode.

The bottom row shows the actual operating levels of the system during x-ray emission. The operating kV level displays directly below the set kV level, the actual tube current (mA) displays directly below the set mA, and the actual time (or mAs) remaining/elapsed displays directly below the set exposure duration, (refer to Figure 4-2).

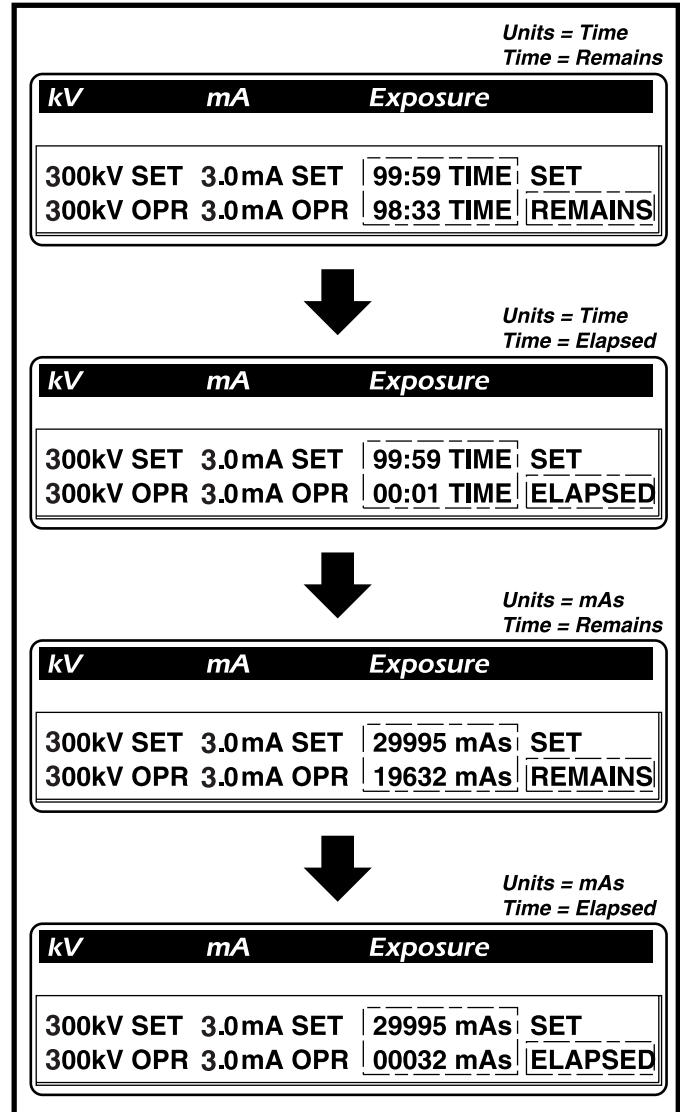

Figure 4-2:  
Samples: Exposure Technique LCD Display

### The Message / Mode LCD Display Screen

The Message / Mode LCD (small bottom screen) displays:

- ◆ operating mode
- ◆ user prompts
- ◆ error messages

The upper left side of the screen indicates the system operational mode (OPERATE or AUTOWARM), and the lower left side show the either the type of automatic warm-up has been selected (i.e., > 30 DAYS), or if an error condition has been encountered (FAULT).

The right hand side of the screen indicates the following:

- ◆ the current operating status
- ◆ the description of the detected fault

Figure 4-3 shows several examples of the information provided on the Message / Mode screen.

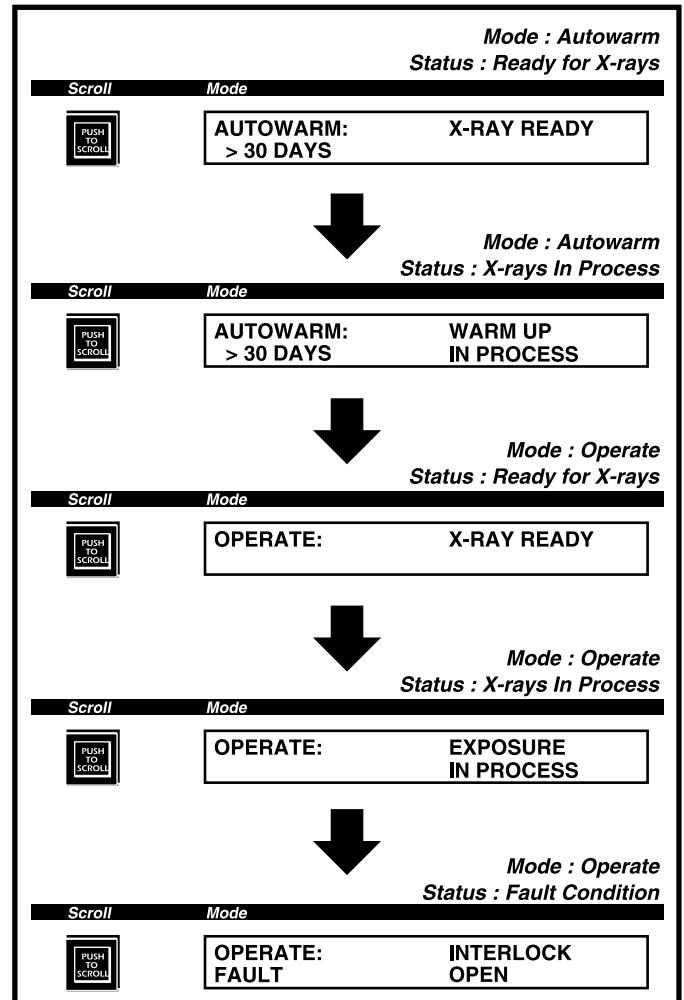

Figure 4-3:  
Samples: Message / Mode LCD Display Screen

### FRONT PANEL CONTROLS AND INDICATORS

The paragraphs that follow describe each of the controls and indicators on the front panel of the Control Unit. Refer to Figure 4-1 for the location of each control and indicator.

#### The MAINS Switch

on

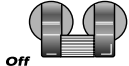

off

The MAINS switch is a two position circuit breaker that applies power to the Control Unit. Switching the MAINS breaker ON applies line power to the Control Unit after a 2 second delay (approximate). During this delay, the input power detection circuitry determines the line voltage (100VAC or 200VAC), and selects the proper line circuitry.

Switching the MAINS breaker OFF immediately disconnects the system from line power. The MAINS breaker will trip automatically during over-current conditions, thus protecting the internal electronics from damage.

#### The MAINS ON Indicator



The MAINS ON indicator is a light emitting diode (LED) array located next to the MAINS Switch. This LED glows green when line power is applied to the system.

#### The SAFETY Switch

Locked Off



on

The 2-position SAFETY switch prevents unauthorized use of the X-ray Unit. Before the system can generate x-rays, the operator MUST insert the key into the SAFETY switch, then rotate it to the ON position. The SAFETY switch does not activate x-ray generation; it only permits use of the x-ray apparatus.

Never approach the Tubehead when power is ON without first placing the SAFETY switch to LOCKED OFF, then removing the key. NEVER leave the key in the SAFETY switch unattended.

#### The kV SET Controls

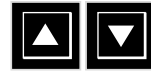

Two pushbuttons, below the kV readout, comprise the kV SET Controls. Use these buttons to increment or decrement the kV level for the exposure. Pressing the kV UP button, identified by the “up arrow” label, increments the set kV in 1kV steps (up to 300kV maximum). Pressing the kV DOWN button, identified by the “down arrow” label, decrements the set kV in 1kV steps (to 0kV minimum).

For rapid change, press and hold the kV UP or DOWN button; for slow change, press and release the buttons. These switches are active:

- ◆ upon initial system power up
- ◆ during an exposure (OPERATE)
- ◆ prior to an exposure (provided the Exposure Counter has been reset)

#### The mA SET Controls



Two pushbuttons, below the mA readout, comprise the mA SET Controls. Use these buttons to increment or decrement the mA level for the exposure. Pressing the mA UP button, identified by the “up arrow” label, increments the set mA in 0.1mA steps (up to 10mA maximum). Pressing the mA DOWN button, identified by the “down arrow” label, decrements the set mA in 0.1mA steps (to 0.0mA minimum).

For rapid change, press and hold the kV UP or DOWN button; for slow change, press and release the buttons. These switches are active upon:

- ◆ upon initial system power up
- ◆ during an exposure (OPERATE)
- ◆ prior to an exposure (provided the Exposure Counter has been reset)

#### NOTE:

*The microcomputer limits the maximum mA to values which, at the set kV level, provide a maximum of 900 watts to the tube.*

### The EXPOSURE SET Controls

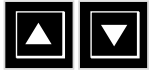

Two pushbuttons, below the Exposure readout, comprise the EXPOSURE SET Controls. Use these buttons to increment or decrement the exposure time (Time Mode) or mAs (mAs Mode). Pressing the EXPOSURE UP button, identified by the “up arrow” label, increments the set exposure time (up to 99:59 maximum), or the set mAs (up to 29995 maximum). Pressing the EXPOSURE DOWN button, identified by the “down arrow” label, decrements the set exposure time (to 00:00 minimum), or the set mAs (to 00000mAs minimum).

For rapid change, press and hold the UP or DOWN button; for slow change, press and release the buttons. These switches are active:

- ◆ upon initial system power up
- ◆ in the OPERATE mode
- ◆ prior to an exposure (provided the Exposure Counter has been reset)

### The UNITS Control



The UNITS Control is a single pushbutton, next to the EXPOSURE SET Controls, that changes the mode that the system uses to determine the exposure duration. Pressing the UNITS button will toggle the system exposure determination mode between TIME and mAs.

Selecting TIME causes the x-ray system to terminate the exposure after a pre-determined “time” has elapsed, regardless of the set exposure factors (kV and mA). Selecting mAs causes the x-ray system to terminate the exposure after achieving a set tube current / time product (mAs), and does not require an operator time calculation.

When the x-ray system is in the TIME mode, TIME SET will appear next to the set exposure time (top row) in the Exposure Factor LCD. When the x-ray system is in the mAs mode, mAs will appear next to the set mAs (top row) in the Exposure Factor LCD.

This switch is active upon:

- ◆ upon initial system power up
- ◆ upon system exposure termination
- ◆ upon exposure interruption
- ◆ after resetting the Exposure Counter

### The TIME Control



The TIME Control is a single pushbutton, next to the UNITS Control, that switches the exposure clock between ELAPSED mode (count up), and REMAINS mode (count down). This control is active at all times when power is ON.

ELAPSED mode sets the time or mAs in the lower Exposure readout to zero, then increments during the exposure. When the “elapsed” time or mAs matches the set time or mAs (upper Exposure readout), the system terminates the exposure.

REMAINS mode sets the time or mAs in the lower Exposure readout to the set time or mAs (upper Exposure readout), then decrements during the exposure. When the “remains” time or mAs reaches zero, the system automatically terminates the exposure.

### The RESET Control

The RESET control is a single pushbutton, next to the TIME Control, that resets the exposure timer. Pressing the RESET control causes the exposure duration (lower readout) to do one of the following:

- ◆ Return to the set time or mAs (REMAINS mode)
- ◆ Return to zero (ELAPSED mode)

The RESET pushbutton is active only when:

- ◆ the system terminates the exposure upon reaching the set duration
- ◆ the system terminates the exposure due to a fault condition
- ◆ the user interrupts the exposure by pressing STOP



### The SCROLL Control



The SCROLL Control is a single pushbutton, to the left of the Message / Mode LCD, that switches the system status between the available modes. Pressing the SCROLL button switches the display in the Message / Mode LCD between:

- ◆ OPERATE
- ◆ AUTOWARM > 30 DAYS
- ◆ AUTOWARM 7 - 30 DAYS
- ◆ AUTOWARM 16 HRS - 7 DAYS
- ◆ AUTOWARM 8 HRS - 16 HRS
- ◆ AUTOWARM 4 HRS - 8 HRS
- ◆ STORE MODE
- ◆ RECALL MODE

Select the OPERATE mode to make radiographs after completing the appropriate warm-up sequence (if required). Select the appropriate AUTOWARM mode to “run up” to the required kV level at a fixed rate when the equipment has not been used for a period of time (see “Warm Up Sequence” in Chapter 5).

### The X-RAY ON Control



The X-RAY ON Control, identified by the radiation symbol, starts x-ray generation, and turns on the X-RAY INDICATOR. The X-RAY ON Control is active only when all of the following conditions are met:

- ◆ power is applied to the system
- ◆ The keyswitch is turned ON
- ◆ all error / fault conditions have been corrected

### The X-RAY Indicator



The X-RAY indicator, next to the X-RAY ON control, is a light emitting diode (LED) that glows red when x-rays are being generated.

### The X-RAY OFF Control

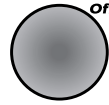

The X-RAY OFF control is the red, mushroom-type pushbutton switch, near the bottom of the control panel. Pressing this switch anytime during an exposure causes:

- ◆ termination of x-ray production
- ◆ the exposure counter to stop
- ◆ the x-ray on LED to extinguish

The timer will continue to display the exposure time or mAs (elapsed or remaining). To continue with the exposure, re-press the X-RAY ON button. The exposure will continue from the point that the OFF control was originally pressed. To start a new exposure, press the RESET button, set new exposure factors, then re-press the X-RAY ON button.



# Chapter 5:

## LPX-300 X-ray System Operation

### INTRODUCTION

This section provides, as an example, the sequence of operation required for using the LPX-300 X-ray System for making x-ray film exposures. ALWAYS keep in mind the dangers inherent with generating x-radiation, and observe ALL the relevant precautions and procedures regarding safe operation, personnel exposure prevention, and exposure dose monitoring.

### Pre-Operational Safety Precautions

Before the x-ray tube is energized for either the warm-up sequence, or for the exposure, the operator MUST understand and observe the safety precautions detailed below.

The interconnects supplied with the system help protect the user, and others in the immediate vicinity, from exposure by providing a safe distance between the Tubehead and the Control Unit. Refer to NCRP (National Council on Radiation Protection) recommended practices for minimum distance requirements.



**! WARNING !**  
**ALWAYS use the cables and hoses provided with the unit to avoid radiation hazards in un-shielded, outdoor operating conditions.**



**! WARNING !**  
**Connect all cables to their appropriate connectors on the Control Unit, Cooling Unit, and Tubehead BEFORE applying power to the system.**

The operator of this apparatus MUST ensure that all personnel are clear of the hazardous X-ray area before generating X-rays. Utilize flashing beacons and/or audible alarms during exposures, which warn personnel of the radiation hazards.



**! WARNING !**  
**All personnel in the immediate vicinity MUST wear personal radiation monitoring devices. Post radiation warning signs where necessary.**

The operator of this X-ray unit, or any person in the immediate vicinity, may be subject to receiving some exposure to X-radiation during the time that the X-ray unit is generating X-rays. Since X-rays can cause harmful effects to the human body, avoid unnecessary exposure.



**! WARNING !**  
**Keep all necessary exposure to an absolute minimum and compatible with practical requirements and current safety regulations. An X-ray survey meter, placed in the vicinity of the Control Unit and operator, is recommended.**

### X-RAY TUBE WARM UP

The X-ray tube provided with the LPX-300 has been pre-aged by the original manufacturer, and further tested and aged by LORAD. It is necessary, however, to run the voltage up to the required kV level at a fixed rate when the equipment has not been used for a period of time.

The LPX-300 incorporates an AUTOWARM feature, which permits the user to select and initiate one of five automatic warm-up sequences. An AUTOWARM sequence is required whenever the x-ray system:

- ◆ is to be operated above 100kV
- ◆ has not been operated at the required kV level for the next exposure for 4 hours
- ◆ has a new tube with less than ten hours of operation

The AUTOWARM modes automatically set the run-up level to 300kV. However, it is only necessary to run the x-ray tube to the kV level required for the next exposure. Run the appropriate AUTOWARM sequence until the kV advances to the next level higher than required for the exposure, then terminate the sequence. Tubes having been previously operated, but not run over 100kV for 30 days or longer, must be treated as new tubes.

Note that for ALL AUTOWARM modes, detected tube instability (as might occur with a new tube) causes the system to automatically terminate x-ray generation. The Message / Mode LCD will display an error (FAULT ARC RESTART), which will require the user to re-activate x-ray generation. The kV will then rise to a level 20kV below where the fault occurred and operate for two minutes. After two minutes, the kV advances to the next highest incremental kV level on the selected warm-up schedule, and the AUTOWARM sequence continues normally from that point.

The five AUTOWARM sequences are detailed next.

### Autowarm Sequence : > 30 Days

The following procedure outlines the steps to “run-up” the kV to the level required for the next exposure in cases where the unit has not been operated for 30 days or more.

1. Prepare the x-ray system for the warm-up sequence:
  - Turn the anode shield to completely block x-ray port.
  - Close all interlock connections, or install the jumper on the INTERLOCK connector.
  - Place the MAINS circuit breaker ON.



#### **! WARNING !**

**Although the window is blocked, do not approach the Tubehead during the warm up process. Observe all applicable safety precautions and survey the area to assure adequate radiation limits.**

2. Begin the AUTOWARM sequence:
  - Select AUTOWARM : > 30 DAYS by pressing the SCROLL button.
  - Clear all unauthorized personnel from the area, and activate all warning devices.
  - Press the X-RAY ON button to begin the AUTOWARM sequence.



#### **! WARNING !**

**The system will now generate x-rays. Observe ALL safety precautions.**

Upon activation, the kV level rises to 150kV and the mA rises to 6.0mA. After 2 minutes at this level, the kV automatically increments 5kV. This slow “ramp up” sequence continues automatically until 300kV is reached (or until terminated by the operator or by a fault), then automatically terminates x-ray generation.

The LPX-300 is ready for use, as indicated by the prompt on the Message / Mode LCD: **OPERATE: X-RAY READY.**

### Autowarm Sequence : 7 - 30 Days

The following procedure outlines the steps to “run-up” the kV to the level required for the next exposure in cases where the unit has not been operated in the last 7 days, but within the last 30 days.

1. Prepare the x-ray system for the warm-up sequence:
  - Turn the anode shield to completely block x-ray port.
  - Close all interlock connections, or install the jumper on the INTERLOCK connector.
  - Place the MAINS circuit breaker ON.



**! WARNING !**  
**Although the window is blocked, do not approach the Tubehead during the warm up process. Observe all applicable safety precautions and survey the area to assure adequate radiation limits.**

2. Begin the AUTOWARM sequence:
  - Select AUTOWARM : 7 - 30 DAYS by pressing the SCROLL button.
  - Clear all unauthorized personnel from the area, and activate all warning devices.
  - Press the X-RAY ON button to begin the AUTOWARM sequence.



**! WARNING !**  
**The system will now generate x-rays. Observe ALL safety precautions.**

Upon activation, the kV level rises to 150kV and mA rises to 6.0mA. After 1 minute at this level, the kV automatically increments 5kV. This slow “ramp up” sequence continues automatically until 300kV is reached (or until terminated by the operator or by a fault), then automatically terminates x-ray generation.

The LPX-300 is ready for use, as indicated by the prompt on the Message / Mode LCD: **OPERATE: X-RAY READY.**

### Autowarm Sequence : 16 Hrs. - 7 Days

The following procedure outlines the steps to “run-up” the kV to the level required for the next exposure in cases where the unit has not been operated in the last 16 hours, but within the last 7 days.

1. Prepare the x-ray system for the warm-up sequence:
  - Turn the anode shield to completely block x-ray port.
  - Close all interlock connections, or install the jumper on the INTERLOCK connector.
  - Place the MAINS circuit breaker ON.



**! WARNING !**  
**Although the window is blocked, do not approach the Tubehead during the warm up process. Observe all applicable safety precautions and survey the area to assure adequate radiation limits.**

2. Begin the AUTOWARM sequence:
  - Select AUTOWARM : 16HRS - 7 DAYS by pressing the SCROLL button.
  - Clear all unauthorized personnel from the area, and activate all warning devices.
  - Press the X-RAY ON button to begin the AUTOWARM sequence.



**! WARNING !**  
**The system will now generate x-rays. Observe ALL safety precautions.**

Upon activation, the kV level rises to 150kV and mA rises to 6.0mA. After 1 minute at this level, the kV automatically increments 10kV. This slow “ramp up” sequence continues automatically until 300kV is reached (or until terminated by the operator or by a fault), then automatically terminates x-ray generation.

The LPX-300 is ready for use, as indicated by the prompt on the Message / Mode LCD: **OPERATE: X-RAY READY.**

# LPX-300

## Industrial Imaging System

---

### Autowarm Sequence : 8 Hrs. - 16 Hrs.

The following procedure outlines the steps to “run-up” the kV to the level required for the next exposure in cases where the unit has not been operated in the last 8 hours, but within the last 16 hours.

1. Prepare the x-ray system for the warm-up sequence:
  - Turn the anode shield to completely block x-ray port.
  - Close all interlock connections, or install the jumper on the INTERLOCK connector.
  - Place the MAINS circuit breaker ON.



**! WARNING !**

**Although the window is blocked, do not approach the Tubehead during the warm up process. Observe all applicable safety precautions and survey the area to assure adequate radiation limits.**

2. Begin the AUTOWARM sequence:
  - Select AUTOWARM : 8HRS - 16 HRS by pressing the SCROLL button.
  - Clear all unauthorized personnel from the area, and activate all warning devices.
  - Press the X-RAY ON button to begin the AUTOWARM sequence.



**! WARNING !**

**The system will now generate x-rays. Observe ALL safety precautions.**

Upon activation, the kV level rises to 150kV and mA rises to 6.0mA. After 1 minute at this level, the kV automatically increments 20kV. This slow “ramp up” sequence continues automatically every 1 minute until 300kV is reached (or until terminated by the operator or by a fault), then automatically terminates x-ray generation.

The LPX-300 is ready for use, as indicated by the prompt on the Message / Mode LCD: **OPERATE: X-RAY READY.**

### Autowarm Sequence : 4 Hrs. - 8 Hrs.

The following procedure outlines the steps to “run-up” the kV to the level required for the next exposure in cases where the unit has not been operated in the last 4 hours, but within the last 8 hours.

1. Prepare the x-ray system for the warm-up sequence:
  - Turn the anode shield to completely block x-ray port.
  - Close all interlock connections, or install the jumper on the INTERLOCK connector.
  - Place the MAINS circuit breaker ON.



**! WARNING !**

**Although the window is blocked, do not approach the Tubehead during the warm up process. Observe all applicable safety precautions and survey the area to assure adequate radiation limits.**

2. Begin the AUTOWARM sequence:
  - Select AUTOWARM : 4HRS - 8 HRS by pressing the SCROLL button.
  - Clear all unauthorized personnel from the area, and activate all warning devices.
  - Press the X-RAY ON button to begin the AUTOWARM sequence.



**! WARNING !**

**The system will now generate x-rays. Observe ALL safety precautions.**

Upon activation, the kV level rises to 150kV and mA rises to 6.0mA. After 1 minute at this level, the kV automatically increments 30kV. This slow “ramp up” sequence continues automatically every 1 minute until 300kV is reached (or until terminated by the operator or by a fault), then automatically terminates x-ray generation.

The LPX-300 is ready for use, as indicated by the prompt on the Message / Mode LCD: **OPERATE: X-RAY READY.**

### OPERATION - LPX-300 X-RAY SYSTEM

When the x-ray system is properly assembled, all safety precautions/practices taken, and the appropriate AUTOWARM sequence complete, the user may make exposures by performing the sequence of operation that follows.

Strictly observe all NOTES, CAUTIONS, and WARNINGS in this section to avoid damaging the equipment, or injuring personnel. Read the "SAFETY SUMMARY" in Section 1, and the WARNINGS outlined under "Pre-Operational Safety Precautions" in this section before proceeding.

#### Sequence of Operation

The following provides, as an example, the sequence required to make x-ray exposures using the LPX-300 Industrial X-ray System.

1. Prepare the LPX-300 for use:
  - Make all the cable and hose interconnections (see Chapter 2).
  - Perform all the pre-operational checks and inspections to confirm system integrity.
  - Make the appropriate interlock connections, or install the interlock jumper.
  - Place the key in the keylock and turn it to LOCKED OFF.
  - Apply power to the system by switching the Power Circuit Breaker ON.

After approximately 2 seconds, the green MAINS LED indicator will illuminate, the Cooling Unit or fan (on air-cooled units) will start, the Control Unit's cooling fan will start, and information will appear in the Exposure Technique LCD.

2. Perform the appropriate AUTOWARM Sequence:
  - Determine the amount of time the system has been idle.
  - Press SCROLL until the Message / Mode LCD displays the appropriate AUTOWARM mode.
  - Cover the anode port with the lead shield.
  - Turn the Keyswitch to ON.
  - Press and hold the X-RAY ON button for approximately 3 seconds to initiate x-ray generation.
  - Press the OFF button after the x-ray tube ramps up to the level of the ensuing exposure.
  - Turn the Keyswitch to LOCKED OFF.

3. Set the appropriate techniques for the exposure:
  - Press SCROLL until the Message / Mode LCD reads: OPERATE : X-RAY READY.
  - Use the kV Controls to set the exposure kV level.
  - Use the mA Controls to set the exposure mA level.
  - Press the UNITS button to select the exposure timing method (time or mAs).
  - Use the Exposure Controls to set the exposure time or mAs.
  - Press the TIME button to set the counter for either count up (elapsed) or count down (remains).
4. Begin the exposure:
  - Remove the key from the Keyswitch.
  - Position the film holder and Tubehead for the ensuing exposure.
  - Turn the lead shield to completely uncover the anode port.
  - Clear all unnecessary personnel from the vicinity.
  - Check that all external warning devices are working properly.
  - Insert the key into the Keyswitch and turn it ON.
  - Press the X-RAY ON button to begin the exposure.



#### **! WARNING !**

**NEVER allow the x-ray unit to run unattended, and NEVER approach the Tubehead with power applied and the key in Keyswitch.**

# LPX-300

## Industrial Imaging System

---

5. Ending the exposure:
  - X-ray generation ends automatically after the set time/mAs duration.
  - Press the OFF button to immediately terminate the exposure before the set duration.
  - Place the Keyswitch to LOCKED OFF and remove the key.
  - Press the X-RAY ON button to restart an exposure that was manually terminated.
  
6. Starting a new exposure:
  - Remove the key from the Keyswitch.
  - Reposition the Tubehead as necessary.
  - Replace the film or film holder as required.
  - Press the RESET button to reset the exposure time duration.
  - Check and adjust the exposure factors as required.
  - Clear the area of unnecessary personnel.
  - Close all interlocks and start all warning signals.
  - Insert the key into the Keylock and place it to ON.
  - Press the X-RAY ON button to begin x-ray generation.
  
7. Unit shut down after exposure termination:
  - Turn the Key lock to LOCKED OFF.
  - Wait five minutes for the cooling unit or fan to cool the x-ray tube anode.
  - Place the MAINS circuit breaker OFF.
  - Remove the power cord from its source.
  - Disconnect all cables and hoses, and replace all covers.
  - Secure the key in a safe, controlled area to prevent unauthorized use.
  - Store the x-ray unit in a cool, dry location that provides secure storage.

Note that if the kV level required for the next exposure is higher than the kV level for the previous exposure, the x-ray tube must be “ramped up” to that kV level by performing the appropriate AUTOWARM cycle.

### LPX-300 FAULT MESSAGES

During operation, if a fault condition occurs, x-ray generation automatically terminates and FAULT messages appear in the Message / Mode LCD. The following is a list of the fault messages that may appear and instructions on correcting the fault.

#### ***INTERLOCK:***

The connection between pins “A” and “B” of the INTERLOCK connector has been interrupted. Check that the interlocked enclosure door switches are operable and closed, or check the jumper for proper installation.

#### ***FLOW:***

Coolant flow from the Cooling Unit to the Tubehead has been interrupted. Check that the Cooling Unit is running, or check the twin coolant hose for proper attachment.

#### ***TEMPERATURE/PRESSURE:***

The Tubehead has overheated or the gas pressure has dropped below 25 psi. Make sure the Cooling Unit (liquid-cooled units) or the cooling fan (air-cooled units) is working properly. Check the gas pressure within the Tubehead. If the pressure is below 25 psi @ 70°F, perform the Re-pressurization or Re-Filling procedure (whichever is appropriate) in Section 6 of this manual.

#### ***ARC DETECTED:***

This fault condition is usually due to instability from a new tube or from an inadequate warm up sequence. Restart the system and perform another AUTOWARM sequence. If the ARC DETECTED fault occurs repeatedly on restart, refer to the X-RAY TUBE SEASONING (later in this section).

#### ***EXCESS kV:***

This condition occurs if the drive voltage to the high voltage inverter (in the Control Unit) exceeds a factory set level. If the Excess kV fault occurs repeatedly after restart, service is necessary.

#### ***X-RAY SW. ERROR:***

Upon power up the computer checks the X-RAY ON button for a short circuit and displays this message if a short is detected. X-ray generation cannot be initiated in this condition, and service is necessary.

### X-RAY TUBE SEASONING

It is normal in new tubes, or in tubes that have not been used for extended periods, to have tube seasoning reactions during use (OPERATE or AUTOWARM). These reactions are a necessary part of the seasoning process in the tube, and can be expected until the tube operates for at least 30 hours.

If seasoning reactions occur during AUTOWARM, x-ray generation automatically stops, and the Message / Mode LCD displays the error condition: ARC DETECTED - RESTART. To clear the error, re-activate x-ray generation by pressing the X-RAY ON control. The kV level will rise to 20kV below the level where the reaction occurred and operate for 2 minutes. After 2 minutes, the kV level rises to the next highest incremental kV level on the selected AUTOWARM schedule, then proceeds normally.

If the automatic reduction of kV reduces the kV level below 100kV, the Message / Mode LCD displays the error condition: ARC SERVICE. When this occurs, switch the MAINS power switch OFF, then back ON to restart the AUTOWARM sequence.

Occasionally with a new tube, or with a tube that has been dormant, reactions occur at kV levels below 100kV. This prevents the kV level to rise to 100kV, and causes the ARC SERVICE error message to show immediately after pressing the X-RAY ON button.

When this occurs, press SCROLL to place the system in the OPERATE : X-RAY READY mode, then set the system for an exposure at 5.0mA, and 0kV. Press the X-RAY ON button and increase the kV level - one kV per second - for 30 seconds (to 30kV), and verify that the mA rises to 5.0mA. After 30 seconds of operation at 30kV, 5.0mA, advance the kV level in 10kV increments every 30 seconds to 100kV. Switch the MAINS OFF, then back ON, then use the appropriate AUTOWARM sequence to warm-up the x-ray tube to the level for the exposure.



# Chapter 6:

## LPX-300 Routine Upkeep and Care

### INTRODUCTION

The LPX-300 System is a reliable, easily maintained, industrial x-ray device. With modest amounts of upkeep and care, this system will provide years of trouble-free operation. This section provides inspections and maintenance practices to follow to reduce the possibility of equipment breakdown and optimize the unit's reliability.

Some of these practices are conducted in accordance with a pre-arranged schedule (inspections and cleaning), while others require attention only when the need arises (re-pressurizing or re-filling the Tubehead).

### INSPECTION CHECKLISTS

To assist in early detection of potential problems, adhere to the "Inspection Checklists" in the following tables. Note ALL discrepancies discovered during these inspections and immediately correct them to avoid equipment breakdown. Perform the inspections described in these checklists on a weekly basis.

**NOTE:**

*When operating in harsh environments, perform the following inspection checks more often due to the higher concentration of dust and debris accumulating within each assembly.*

### Tubehead Checklist

- Pressure Gauge \_\_\_\_\_ Gauge in good condition  
Gas pressure 50 psi @ 70°F
- Gas Valve Cap \_\_\_\_\_ Securely fastened to charging valve.
- Twin Hose Connectors \_\_\_\_\_ Check for dents, nicks, corrosion;  
Check that hose couplings seat properly.
- Cable Connector \_\_\_\_\_ Ensure all pins are straight.  
Check for corrosion or debris.  
Check condition of threads.
- Tubehead Handles \_\_\_\_\_ Check for cracks or breaks.
- Lead Shield \_\_\_\_\_ Check for cracks or dents.  
Ensure shield rotates freely.
- Tubehead Housing \_\_\_\_\_ Paint finish in good condition  
Check for dents and visible damage.

# LPX-300

## Industrial Imaging System

---

### Control Unit Checklist

- Cabinet and Cover \_\_\_\_\_ Paint finish in good condition;  
Check for dents & visible damage;  
Check for loose hardware.
- Cable Connectors \_\_\_\_\_ Firmly seated on front panel;  
Check for bent or broken pins;  
Check for corrosion or debris;  
Check for cracked receptacles;  
Check thread condition.
- kV and mA Controls \_\_\_\_\_ Check for cracked or broken  
pushbuttons.
- Indicator Lamps \_\_\_\_\_ Illuminate when activated.
- Exposure Timer \_\_\_\_\_ (+) and (-) buttons operate;  
RESET button operates.
- Fan \_\_\_\_\_ Operates when power is applied.
- Air Filter \_\_\_\_\_ Clean and secure.

### Cooling Unit Checklist

- Coolant Level \_\_\_\_\_ Radiator cap is easily removed;  
Fluid level within 1/2" from top.
- Radiator \* \_\_\_\_\_ Check for cleanliness;  
Check for dents, cracks or  
damage.
- Hoses \* \_\_\_\_\_ Hose clamps firmly attached;  
Check for cuts, cracks or dry rot.
- Drive Belt \* \_\_\_\_\_ Check for cracks or frayed areas;  
Check for proper belt tension.
- Air Filter \* \_\_\_\_\_ Check for cracks, visible damage;  
Check for cleanliness.
- Pump Assembly \* \_\_\_\_\_ Rotates freely;  
Check for signs of leakage.
- Motor and Fan \* \_\_\_\_\_ Rotates freely;  
Check for dents or cracks.

\* Remove Equipment Covers to perform inspection.

### Interconnecting Cables & Hose Checklist

- Military Connectors \_\_\_\_\_ Secured firmly to cable;  
Check for corrosion or debris;  
Check for bent or broken pins;  
Check for cracked or broken  
housing.
- Cable Insulation \_\_\_\_\_ Check for cracks, holes or frays;  
Check for signs of wear or dry rot.
- Hose Couplings \_\_\_\_\_ Couplings secured firmly to hose;  
Check for corrosion or blockage.
- Hoses \_\_\_\_\_ Check hoses for cracks, punctures;  
Check for visible signs of leakage.

### CLEANING THE LPX-300 X-RAY UNIT

During normal periods of use, but especially in harsh environmental operating conditions, it becomes necessary to clean each assembly of the system. This cleaning should be performed once a month under normal operating condition, to optimize performance and minimize equipment failure during use.

The following paragraphs describe the materials and the steps needed to clean the LPX-300 X-ray unit.

#### Required Cleaning Materials

- ◆ Clean lint free cloths
- ◆ Mild detergent
- ◆ 1" soft bristled paint brush
- ◆ Electronic cleaning solution
- ◆ Acid brushes
- ◆ Low pressure air station, hose and nozzle set

#### Cleaning the X-Ray Unit

The following instructions detail the recommended cleaning method for the LPX-300 X-ray Unit.



**! WARNING !**  
**NEVER access the interior of the Tubehead under any circumstances. When cleaning the Control and Cooling Units, power MUST be OFF and the unit MUST be disconnected from the power source.**

1. Dampen a clean lint free cloth in a solution of warm water and mild detergent. Wring excess water from the cloth to prevent dripping. Remove dirt, dust, or debris from the top cover of the Control Unit. Clean the outer casing of the Tubehead, Control Unit, and Cooling Unit.

2. Remove dirt, dust, or debris from the front panel of the Control Unit using a 1" soft bristled paint brush. To remove dirt that is not easily dislodged, use a lint-free cloth dampened in a warm water and mild detergent solution.



**! CAUTION !**  
**DO NOT allow any water to enter the cable jackets or connectors when cleaning the equipment. Always wring excess water from the cloth.**

3. Remove the Control and Cooling units from their respective cases by first removing the bolts from the bottom of the case, then removing the screws from the top panel. Carefully lift the entire unit out of the case. Using a low pressure air and nozzle system, blow any dirt, dust, or debris out of the unit. Insert the Control and Cooling units back into their respective cases and re-assemble.

#### NOTE:

*To clean material that cannot be removed from around circuitry, use a standard electronic cleaning solution and an acid brush.*

4. Inspect the connectors on each cable assembly. Remove any dirt, dust, debris, or foreign material from the pins/sockets with electronic cleaning solution and an acid brush. DO NOT use water. Check for corrosion on the pins or connectors and remove if necessary.
5. The air filters in the Control Unit and the Cooling Unit are washable and should be cleaned periodically. Refer to the procedures outlined under "Control Unit Upkeep" and "Cooling Unit Upkeep" later in this section.

# LPX-300

## Industrial Imaging System

### TUBEHEAD MAINTENANCE

The following paragraphs describe the general maintenance procedures to perform periodically on the Tubehead. Outlined are the steps for Re-pressurizing and Re-filling the Tubehead with sulfur hexafluoride gas, and the conditions under which each are performed. Refer to the set up diagram (Figure 6-1) when adding SF<sub>6</sub> gas to the Tubehead. A Temperature Compensation chart is provided for use in conducting these tasks.

### Temperature Compensation

As shown in Figure 6-2, temperature changes cause SF<sub>6</sub> gas to expand or contract at the rate of 1 psi for every 7°F increase/decrease in ambient air temperature. Allow for these changes when checking the Tubehead gas pressure, or while re-pressurizing/re-filling the Tubehead. The following graph illustrates the maximum and minimum pressure limitation of the Tubehead at various temperature ranges. Use this chart whenever the Tubehead is inspected, re-pressurized, or re-filled.

**NOTE:**

*It is standard practice to allow both the gas supply and the Tubehead to achieve room temperature before attempting to re-pressurize. Temperature equilibrium eliminates errors resulting from differences between the gas supply and the Tubehead temperatures.*

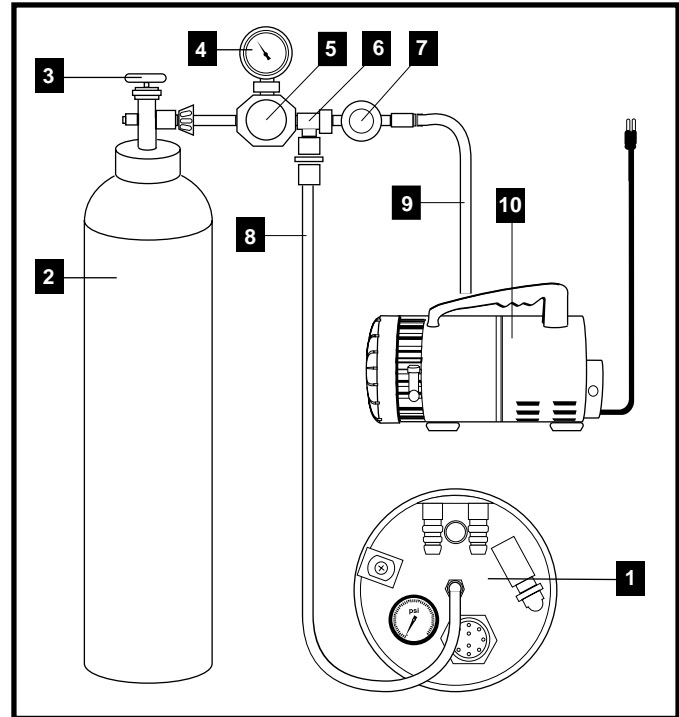

**Figure 6-1:**  
**Tubehead Pressurization Set Up**

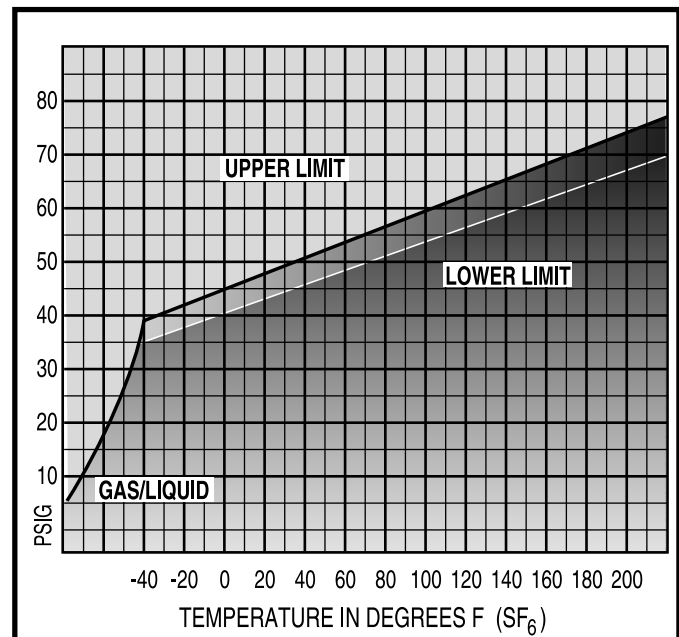

**Figure 6-2:**  
**Pressure vs. Temperature Chart**

### Re-Pressurizing the Tubehead

This x-ray unit operates safely at Tubehead gas pressures as low as 50 psi @ 70°F. Should Tubehead gas pressure fall below this value, but remain above 5 psi (as indicated on the pressure gauge), Re-pressurizing is required.

This procedure details how to re-pressurize the Tubehead with dry sulfur hexafluoride gas to bring the Tubehead gas pressure to within acceptable levels (50 psi @ 70°F). This is done through the charging valve (automobile tire type) on the back plate of the Tubehead assembly. Use a hose incorporated with a relief valve or pressure regulator, and a gauge having an accuracy of at least 4 psi. Note that a charger and maintenance kit for the Tubehead is available, and can be purchased through LORAD (see “Optional Equipment Checklist” in Section 2 of this manual).

Refer to Figure 6-1 and 6-2 while performing this procedure.



#### **! CAUTION !**

**If gas pressure is below 5 psi @ 70°F, contaminants which could cause arcing may have entered the Tubehead chamber. If Tubehead gas pressure is below 5 psi (at 70°F), the Tubehead must be purged and then re-filled (see Re-Filling the Tubehead). DO NOT perform the Re-pressurizing procedure.**

1. Remove the protective cover from the SF6 (sulfur hexafluoride) cylinder (2). Remove the plug from the cylinder valve (3) with a 3/8" allen wrench. The cylinder valve outlet is left-hand threaded.



#### **! WARNING !**

**Use extreme care while handling the cylinder to preventing dropping it after the protective cover has been removed. Secure the cylinder to a stationary post, or secure it against tipping.**

2. Connect the SF6 charging regulator assembly (6), or equivalent, to the SF6 cylinder valve.

#### *NOTE:*

*The pressure regulator supplied with the optional LORAD recharge kit is factory set to 70 - 75 psi @ 70°F, and locked with a hex nut on the adjustment knob. However, due to spring tension aging, and/or various ambient temperatures, this setting may need to be updated.*

3. Connect the Tubehead (1) to the regulator assembly (6) using the hose (8), as shown in Figure 6-1. Leave the SF6 cylinder closed at this time. For this procedure, hose (9), and pump (10) are not required.
4. Open the vacuum line valve (7) slightly, to purge the hose (8) of standing air. Open the SF6 gas cylinder slightly to purge the regulator of any standing air. Now close the vacuum line valve (7), and open the SF6 cylinder valve (3) to its fully open position (against its physical stop).
5. The Tubehead will begin filling with SF6. When the gas gauge indicates the correct pressure, close the SF6 cylinder valve (3). To determine the correct pressure, refer to the “Pressure vs. Temperature” chart (Figure 6-2).
6. Remove the charging hose connection at the Tubehead. Secure the gas cylinder by removing the connections and replacing the protective cover. Recheck the pressure and inspect the Tubehead for leakage.

### Re-Filling the Tubehead

Use this procedure to re-fill the Tubehead in cases where the gas pressure has dropped below 5 psi @ 70°F (refer to Figure 6-1 and 6-2).

1. Remove the protective cover from the SF6 (sulfur hexafluoride) cylinder (2). Remove the plug from the cylinder valve (3) with a 3/8" allen wrench. The cylinder valve outlet is left-hand threaded.



**! WARNING !**  
**Use extreme care while handling the cylinder to preventing dropping it after the protective cover has been removed. Secure the cylinder to a stationary post, or secure it against tipping.**

2. Connect the SF6 charging regulator assembly (6), or equivalent, to the SF6 cylinder valve.

**NOTE:**

*The pressure regulator supplied with the optional LORAD recharge kit is factory set to 70 - 75 psi @ 70F, and locked with a hex nut on the adjustment knob. However, due to spring tension aging, and/or various ambient temperatures, this setting may need to be updated.*

3. Connect the vacuum pump (10) and the Tubehead (1) to the regulator assembly (6), using the hoses (8) and (9) as shown in Figure 6-1.
4. Leaving the SF6 gas cylinder valve (3) closed, open the vacuum line (7) counter-clockwise.
5. Start the vacuum pump and allow it to run for at least 20 minutes. The final vacuum indicated on the regulator gauge should be at least 25" Hg.
6. Close the vacuum line valve (7) and turn the vacuum pump off. Open the SF6 cylinder valve (3) to its fully open position (against its physical stop). Fill the Tubehead until the gauge indicates 25 psi, then close the cylinder valve.

7. Open the vacuum valve and run the pump an additional 10 minutes. Close the vacuum line and stop the pump. Open the SF6 cylinder valve again and fill the Tubehead to the pressure indicated on the "Pressure vs. Temperature" chart (Figure 6-2). When the Tubehead is at the correct pressure, close the SF6 cylinder valve.
8. Remove the charging hose connection at the Tubehead, secure the gas cylinder, and replace the protective cover. Re-check the pressure and inspect the Tubehead for leaks.

### Cleaning - Control Unit Air Filter

Clean the wire mesh air filter within the Control Unit each month to remove dust, dirt, or debris collected during use. Large accumulations of dirt can impede the flow of air through the control unit chassis, which may result in damage to circuit board components. The following describes removing and cleaning the Control Unit's air filter.

1. Remove the 4 screws that secure the filter cover to the left side of the Control Unit.
2. Pull the entire filter cover, with attached filter, out of the Control Unit.
3. Remove the 4 hex nuts that secure the filter to the filter cover. Lift the filter off the cover.
4. Remove any dirt, dust, or debris by washing the filter in a solution of mild detergent and warm water.
5. When complete, rinse the filter thoroughly with clean, warm water. **DO NOT** use gasoline or other solvents to clean the filter.
6. Allow the filter to dry completely, or blow off any remaining moisture with compressed air.
7. Re-install the filter to the filter cover using the previously removed hex nuts. **DO NOT** over tighten or damage may occur to the filter.
8. Insert the filter cover, with attached filter, into the cut-out in the left side of the Control Unit. Secure with the previously removed mounting screws.



### COOLING UNIT UPKEEP

The following paragraphs describe the monthly general maintenance procedures for the Cooling Unit. These tasks include mixing/adding coolant solution, cleaning the air filter, and cleaning the coolant filter. Note that the frequency of these procedures should be adjusted appropriately during times of heavy use or while operation under severe environmental conditions.

#### Mixing & Adding Coolant Solution

After prolonged use (due to evaporation or spillage), or after performing maintenance on the Cooling Unit, add coolant solution to the reservoir. The following procedures describe the methods used to properly formulate and add coolant solution to the Cooling Unit.

1. A plastic container is needed to mix and store the coolant solution. The container should be appropriately sized to accommodate easy handling, have a means of pouring the solution, and a means of capping it off for storage.
2. In this container mix 14 parts of methyl alcohol, with 7 parts distilled water, and 1 part soluble oil (Chevron Soluble D or MOBIL S-122 Soluble). Gently agitate the container to help blend the solution.
3. Remove the top cover from the Cooling Unit, then remove the radiator cap. Check that the coolant level is within specifications. If the coolant level is more than 1/2" from the top of the reservoir, add coolant solution to the reservoir until the level is approximately 1/2" from the top, then replace the radiator cap.
4. Install the twin hose assembly between the Cooling Unit and the Tube Head. Connect the power cable between the Control Unit and the Tube Head, and the power cord between the Control Unit and the Cooling Unit. Apply power and allow the coolant to circulate through the system for approximately three minutes.
5. Turn the system OFF and remove the radiator cap. Inspect the coolant level and ensure it remained within 1/2" from the top of the reservoir. Add more coolant solution if necessary, and repeat step 4.



#### ! CAUTION !

Store the coolant container in a cool, dry area with the cap on. Clearly mark the container so that the contents are easily identifiable.

#### Cleaning - Cooling Unit Air Filter

Clean the wire mesh air filter within the Cooling Unit each month to remove dust, dirt, or debris collected during use. Large accumulations of dirt can impede the flow of air through the radiator assembly, resulting in restricted or limited cooling of the anode. The following procedures describe the steps to remove and clean the Cooling Unit's air filter.

1. Release the four latches that fasten the top cover to the Cooling Unit, then lift the cover off the unit. Remove the ten screws from the top plate, and the four bolts from the bottom of the case. Lift the entire Cooling Unit chassis from the protective case.
2. Remove the four screws (with nuts) securing the grille and filter to the inner side of the protective case.
3. Remove dirt, dust, or debris from the filter by washing it in a solution of mild detergent and warm water. When complete, rinse the filter thoroughly with clean, warm water. DO NOT use gasoline or other solvents to clean the filter. Allow the filter to dry completely, or blow off any remaining moisture with compressed air.
4. Re-install the filter and grille assembly to the protective case. DO NOT over tighten the mounting hardware or distortion to the filter frame may occur.
5. Insert the Cooling Unit chassis into the protective case. Make sure the filter assembly is positioned directly in front of the radiator before tightening mounting hardware.

### Cleaning - Coolant Filter

The Cooling Unit contains a screen-type filter contained within the in-line strainer assembly. This filter is attached to the Cooling Unit chassis. To prevent restricted coolant flow and over-heating of the anode, perform this inspection and cleaning procedure every month.

1. Release the four latches that fasten the top cover to the Cooling Unit, then lift the cover off the unit. Remove the ten screws from the top plate, and the four bolts from the bottom of the case. Lift the entire Cooling Unit chassis from the protective case.
2. Unscrew and remove the cap nut from the strainer assembly (expect coolant solution to seep out while the cap is removed). Lift the filter/strainer out of the assembly, and quickly replace the cap nut to stem the flow of coolant solution.
3. Remove contaminants from the filter with a solution of warm water and mild detergent. The screen is made of delicate material and can be deformed quite easily. Handle the filter with extreme care.
4. Rinse the filter in clean, warm water to remove excess detergent. Remove the cap nut and re-install the filter. Replace the cap nut and tighten.
5. Add coolant solution to the reservoir to compensate for spillage that occurred during cleaning. Clean any coolant solution from the chassis that leaked out during this procedure. Install the chassis into the protective case.
6. Attach the twin hose assembly between the Cooling Unit and the Tubehead, and the Control Unit to the Cooling Unit. Apply power, and allow coolant to circulate for three minutes. Re-check the coolant level to ensure it is 1/2" from the top. Add coolant solution as needed.



**TREX** Medical Corporation  
Lorad Division

# LPX-160 & LPX-200

DIGITAL PORTABLE XRAY UNIT

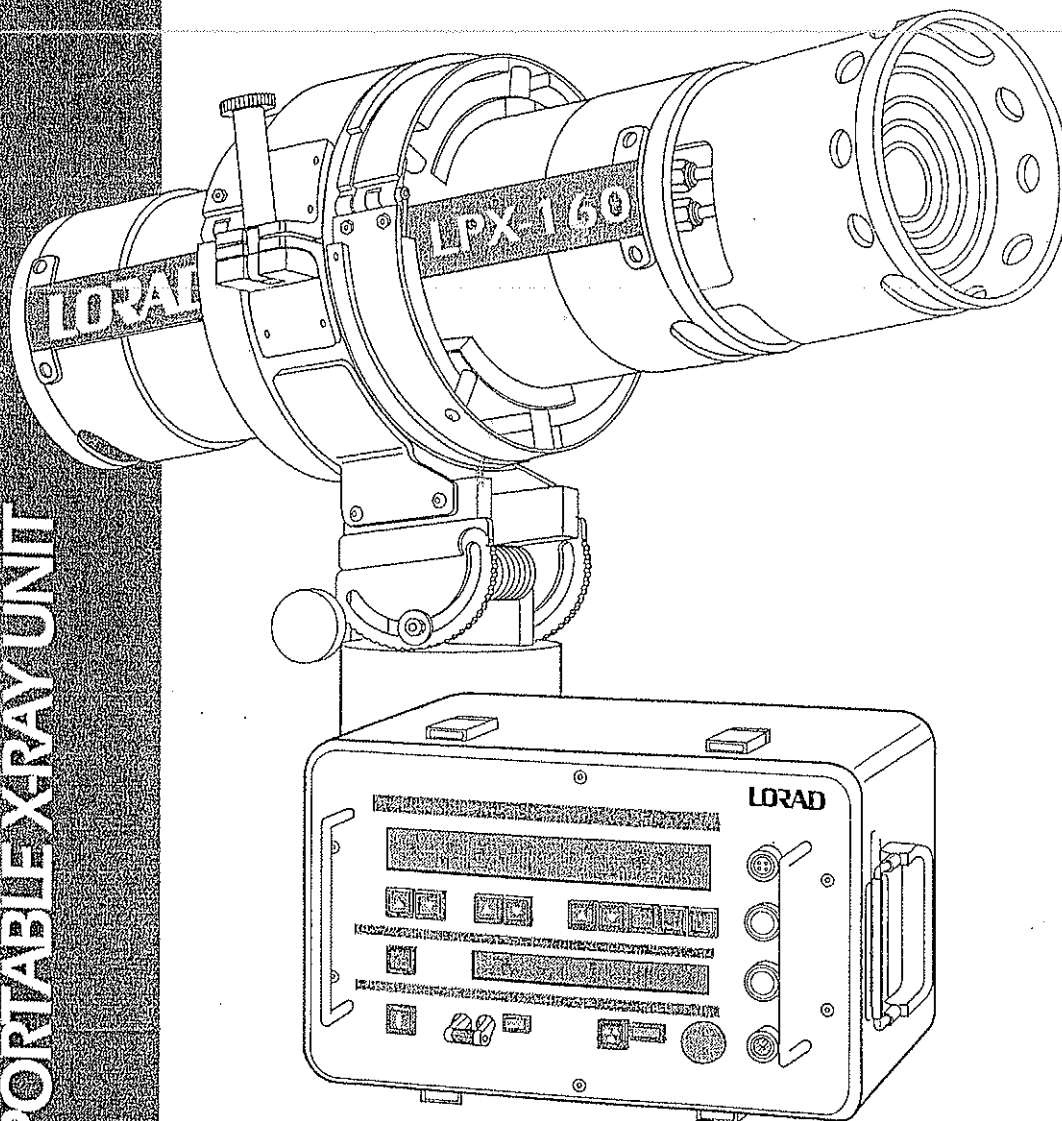

## User's Manual

Exposure Library

9-500-0248

# LPX-160, LPX-200 Exposure Library

## User's Manual

9-500-0248

Revision 1

TABLE OF CONTENTS	LIST OF FIGURES
INTRODUCTION ..... 3	FIGURE 1: The LPX Digital Control Panel .... 2
CONTROLS ..... 3	FIGURE 2: Example Screen, The Store Mode ... 3
Scroll Control ..... 3	FIGURE 3: Example Screen, The Recall Mode . 3
kV Control ..... 4	
mA Control ..... 4	
Exposure control ..... 4	
Units (Time/mAs) Control ..... 4	
Reset/Enter Control ..... 4	
EXPOSURE LIBRARY OPERATION ..... 4	
Storing Technique Combinations ... 4	
Recall Stored Combinations ..... 5	
Changing Stored Combinations ..... 5	

### COPYRIGHT NOTICE

This document is copyrighted by Trex Medical Corporation. No part of this document may be reproduced, transmitted, or copied without the express written permission of:

**TREX** Medical Corporation  
Lorad Division

36 Apple Ridge Road - Danbury, CT 06810 USA  
Phone 203.790.1188 - Fax 203.731.8442

Copyright 1999 by Trex Medical Corporation  
All rights reserved.

**INTRODUCTION**

The Exposure Library is a time saving feature of the LPX-160 and LPX-200 systems that enables the following:

- ◆ Storage of up to 250 exposure factor combinations.
- ◆ Instant recall of stored exposure factor combinations.
- ◆ Display, upon power up, of the last used exposure factor combination

The Exposure Library has two modes of operation:

- ◆ Store Mode
- ◆ Recall Mode

The Store Mode permits the user to place exposure factor combinations (i.e., kV, mA, & Time) into a specific location in system memory. The exposure factor combination is pre-selected in the Operate Mode, and then saved with an assigned a 3-digit location - or address - in the Store Mode. Exposure factor combinations are assigned addresses within the range of 001 to 250. Note that the unit will store exposure durations in time only - not in mAs.

The Recall Mode allows selection of previously stored technique factor combinations. This mode screen shows the memory address and the pre-set exposure parameters. When selected, the exposure factors for that address become the set parameters for the x-ray procedure in the Operate Mode.

The Exposure Library feature also provides the LPX Series unit with the ability to display, upon power up, the exposure factors that were used last. These factors display in the Set Line of the top LCD when in Operate mode.

When the LPX Series unit is equipped with the Exposure Library feature, it is recommended that the user prepare the exposure library as follows:

1. Prepare a master list, or matrix, of the exposure factor combinations and addresses commonly used at your site.
2. Secure the list or matrix to the Control Unit cover or handle for quick reference.
3. Enter all desired exposure factor combinations on the matrix into the system memory using the procedures in this document.

**CONTROLS**

The following paragraphs describe use of the LPX Digital Panel Controls that are involved with the storing and recalling of exposure factors. All exposure factor combination selection is done with the unit in the Operate Mode. In the Store Mode, all of the Exposure Controls except the following are non-functional:

- ◆ Exposure Time (Memory) Select
- ◆ Reset/Enter

Refer to the Operator's Manual shipped with your unit for details on normal exposure controls.

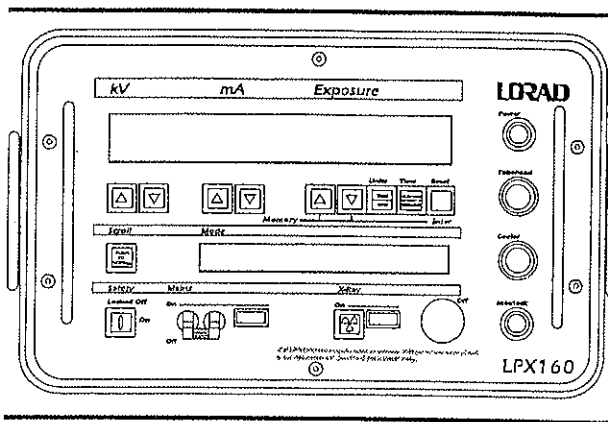

Figure 1:  
The LPX Digital Control Unit

**Scroll Control**





Press this control to cycle through and select from the available modes of system operation:

- ◆ AutoWarm Modes (5 mode)
- ◆ Operate Mode
- ◆ Store Mode
- ◆ Recall Mode

The modes of operation specific to the Exposure Library feature are Store and Recall. Use the Store Mode to assign addresses and store exposure factor combinations. Use the Recall Mode to select an address which contains a previously stored technique factor combination.

**kV Control**

 Use the kV Up and Down buttons in the Operate Mode to set the desired kV level for the exposure factor combination. When a memory address is selected in the Store Mode, the set kV in the upper display will be the saved kV value for that address.

 **NOTICE . . .** The kV UP/DOWN Controls are not functional in the Store Mode.

**mA Control**

 Use the mA Up and Down buttons in the Operate Mode to set the desired mA level for the exposure factor combination. When a memory address is selected in the Store Mode, the set mA in the upper display will be the saved mA value for that address.

 **NOTICE . . .** The mA UP/DOWN Controls are not functional in the Store Mode.

**Exposure Control**

 When the unit is in the Store Mode, use these buttons to scroll through the memory addresses (001 through 250). In the Operate Mode, use these buttons to select the exposure time or mAs (see Operator's Manual for details).

**Units (Time/mAs) Control**

 In the Operate Mode, use this button to switch the exposure timing method between mAs or time (minutes/seconds). Note that when the Exposure Library feature is installed, the Store Mode will only save exposure timing values in minutes & seconds.

 **NOTICE . . .** The LPX Series unit will not store an mAs value.

**Reset/Enter Control**

 The Reset/Enter Control is a 3-function button, depending on the selected mode of system operation:

- ◆ Operate Mode: Resets the exposure (see Operator's Manual)
- ◆ Store Mode: Saves the selected address and the displayed exposure factor combination into system memory.
- ◆ Recall Mode: Selects the displayed address and sets the Operate Mode to make an exposure using the saved technique combinations for that address.

**EXPOSURE LIBRARY OPERATION**

The following paragraphs describe the sequences for storing and recalling exposure factor combinations.

**Storing Technique Combinations**

Storing an exposure factor combination involves selecting a combination of exposure factors, assigning a technique address to that combination, and then saving the combination and address into system memory. The steps listed next present the recommended sequence for this procedure:

1. Perform the Power up and appropriate system Warm Up procedure following the instructions in the Operator Manual. The bottom screen will display the Operate mode, indicating that the system is ready for use.

 **NOTICE . . .** There is no need to perform any AutoWarm procedure when using the system only to store exposure factor combinations and addresses.

2. In the Operate Mode, set the desired kV and mA using the appropriate control buttons.
3. Press the Units Control to set the system for Time (minutes/seconds). Set the desired exposure time using the appropriate control buttons.
4. Press the Scroll button until the lower display shows the Store Mode (see Figure 2).
5. Press the Time controls to select a memory address (001 through 250).
6. Press the Enter button to save the exposure factor combination into memory at the selected address.

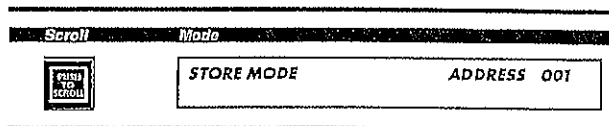

Figure 2:  
Example Screen, Store Mode

**Recalling a Stored Technique Combination**

Recalling a preset exposure factor combination involves displaying the appropriate technique address, then displaying selecting the stored combination. The steps listed next present the recommended sequence:

1. Perform the Power up and appropriate system Warm Up procedure following instructions in the Operator Manual. When the Warmup cycle is complete, the lower screen will display the Operate Mode indicating that the system is ready for use.
2. Press the Scroll button until the Recall Mode screen is displayed in the lower LCD.
3. Press the Time controls to select a memory address (001 through 250). The saved exposure parameters will show below the memory address.
4. Press the Enter button to select the exposure factor combination.
5. The preset exposure factors assigned to this address will now display on the top LCD screen and the mode will switch automatically to Operate.

**Changing Stored Technique Combinations**

To change a factor in a stored combination, follow these steps:

1. In the Operate Mode, use the appropriate controls to select new exposure factors.
2. Access the Store Mode, then select the memory address containing the exposure factor combination to change.
3. Press Enter to store the new exposure factor combination for the selected address.

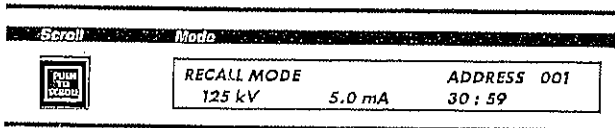

Figure 3:  
Example Screen, Recall Mode

**Artwork and Signature File for:**

**Man-01407 "ADDENDUM, LPX-300 OPS, CABINET USE"**

Artwork consists of:

- Two (2) 8 ½ inch x 11 inch sheet(s) attached.

REV AUTHORED BY	DATE	<b>HOLOGIC™</b>	<del>SIGNATURES ON FILE</del>		
A. TAMBASCIO	05/18/09				
REV DRAFTED BY	DATE				
J. SHARP	05/27/09				
PROPRIETARY INFORMATION: The content of this document is the exclusive property of Hologic and may not, without prior written permission of Hologic, be reproduced, copied or used for any purpose whatsoever.	TITLE		DOCUMENT NUMBER		REV
	ADDENDUM, LPX-300 OPS, CABINET USE		AW-03400		001
	ARTWORK		SIZE A	SHEET 1 OF 1	

**LPX-300 for Cabinet Use**

This Addendum changes Revision 2 of 9-500-0260 LPX-300 Operator's Manual for use when the LPX-300 is used as a cabinet system.

A Note, which references the 21 CFR requirements when the LPX-300 is used as a cabinet system, has been added to page 3-4 of the manual. The changed page 3-4 is attached.

Put this document with your manual for future reference.

# LPX-300

## Industrial Imaging System

### Connecting to Power

Note that the AC voltage source MUST be rated as either:

- ◆ 120 VAC, 20 amps, 50/60 Hz
- ◆ 230 VAC, 10 amps, 50/60Hz

Line voltage selection is automatic. For 220V input application, remove the male plug on the supplied power cord and replace it with one that fits the local AC receptacle, or an adapter cable can be locally manufactured. See Figure 3-3 for the correct plug termination.

### EXTERNAL INTERLOCK CONNECTIONS

#### NOTE:

The LORAD LPX-300 is intended by its manufacturer to be used as a portable x-ray source in compliance with 21CFR Section 1020.31. When using an LPX-300 in cabinet type systems it is the user's responsibility to ensure compliance with 21CFR Section 1020.40 and other federal, state and local regulations.

The INTERLOCK connector on the front panel of the Control Unit enables interconnection of x-ray enclosure doors and/or external warning devices with the internal safety interlock circuitry of the system. Figure 3-4 illustrates the two circuits provided for this purpose.

Pins "A" and "B" are used to connect enclosure door switches. When pins A and B are properly connected, x-ray generation is possible only when the enclosure doors housing the Tubehead are shut. Note that pins "A" and "B" of the INTERLOCK connector must form a closed circuit to operate the X-ray unit. If no external switch interlocks are incorporated, a jumper (provided) must be installed across pins "A" and "B" to form this closed circuit. Pins "C" and "D" provide a switch closure to operate warning devices such as lights, sirens, or other types of external warning signals. These signals warn all personnel that x-rays are being generated.

Pins E and F are for use with optional LORAD pre-warning/warning devices.



**! WARNING !**  
**Voltage is present at pins "A" and "B" of the INTERLOCK when the unit is powered up. Ensure power is OFF before making any external connections or while installing the jumper.**

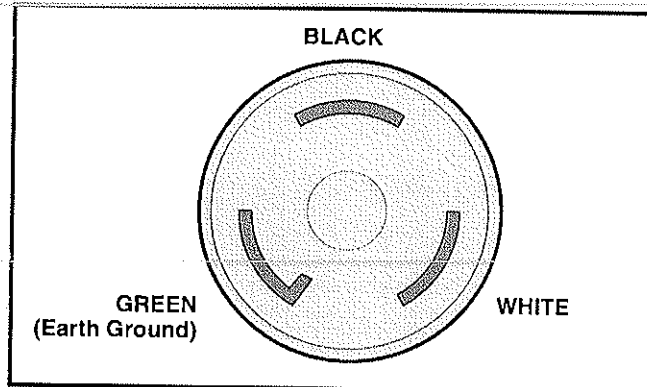

Figure 3-3:  
220 Volt Plug Termination

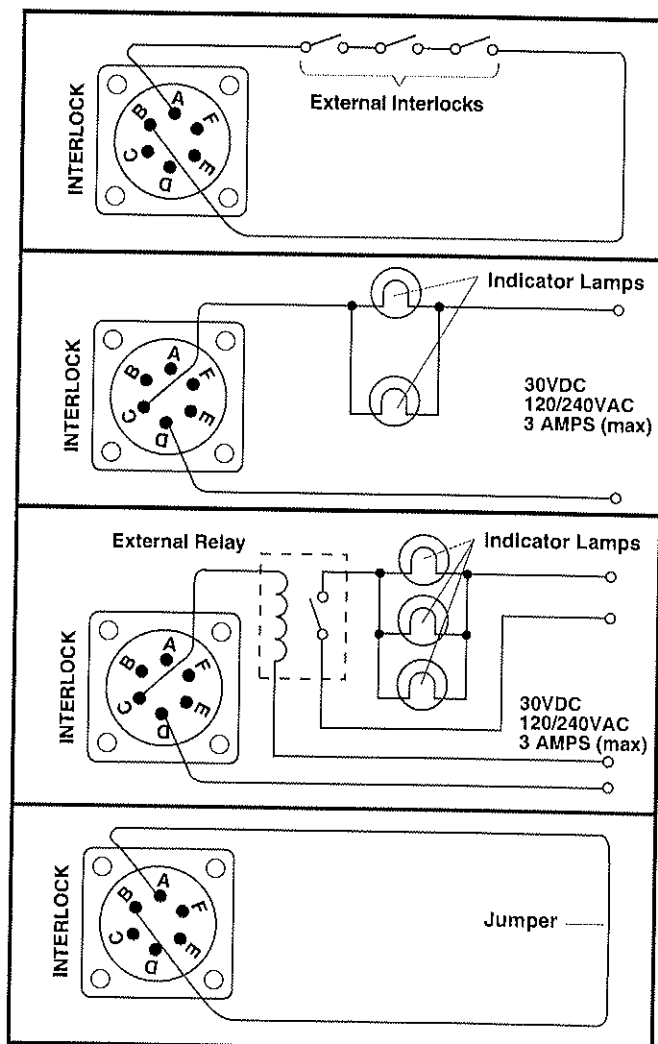

Figure 3-4:  
External Interlock Connections



## IMPORTANT SAFETY PRECAUTIONS

### SAFETY

THIS POWER SUPPLY GENERATES VOLTAGES THAT ARE DANGEROUS AND MAY BE FATAL.  
OBSERVE EXTREME CAUTION WHEN WORKING WITH THIS EQUIPMENT.

High voltage power supplies must always be grounded.

Do not touch connections unless the equipment is off and the Capacitance of both the load and power supply is discharged.

Allow five minutes for discharge of internal capacitance of the power supply.

Do not ground yourself or work under wet or damp conditions.



### SERVICING SAFETY

Maintenance may require removing the instrument cover with the power on.

Servicing should be done by qualified personnel aware of the electrical hazards.

**WARNING** note in the text call attention to hazards in operation of these units that could lead to possible injury or death.

**CAUTION** notes in the text indicate procedures to be followed to avoid possible damage to equipment.

Copyright © 2000, Spellman High Voltage Electronics Corporation. All Rights Reserved.  
This information contained in this publication is derived in part from proprietary and patent data. This information has been prepared for the express purpose of assisting operating and maintenance personnel in the efficient use of the model described herein, and publication of this information does not convey any right to reproduce it or to use it for any purpose other than in connection with installation, operation, and maintenance of the equipment described.

# WICHTIGE SICHERHEITSHINWEISE

## SICHERHEIT

DIESES HOCHSPANNUNGSNETZTEIL ERZEUGT LEBENSGEFÄHRLICHE HOCHSPANNUNG.  
SEIN SIE SEHR VORSICHTIG BEI DER ARBEIT MIT DIESEM GERÄT.

Das Hochspannungsnetzteil muß immer geerdet sein.

Berühren Sie die Stecker des Netzteiles nur, wenn das Gerät ausgeschaltet ist und die elektrischen Kapazitäten des Netzteiles und der angeschlossenen Last entladen sind.

Die internen Kapazitäten des Hochspannungsnetzteiles benötigen ca. 5 Minuten, um sich zu entladen.

Erden Sie sich nicht, und arbeiten Sie nicht in feuchter oder nasser Umgebung.



## SERVICESICHERHEIT

Notwendige Reparaturen können es erforderlich machen, den Gehäusedeckel während des Betriebes zu entfernen.

Reparaturen dürfen nur von qualifiziertem, eingewiesenem Personal ausgeführt werden.

“WARNING” im folgenden Text weist auf gefährliche Operationen hin, die zu Verletzungen oder zum Tod führen können.

“CAUTION” im folgenden Text weist auf Prozeduren hin, die genauestens befolgt werden müssen, um eventuelle Beschädigungen des Gerätes zu vermeiden.

# PRECAUTIONS IMPORTANTES POUR VOTRE SECURITE

## CONSIGNES DE SÉCURITÉ

CETTE ALIMENTATION GÉNÈRE DES TENSIONS QUI SONT DANGEUREUSES ET PEUVENT ÊTRE FATALES.  
SOYEZ EXTRÊMEMENT VIGILANTS LORSQUE VOUS UTILISEZ CET ÉQUIPEMENT.

Les alimentations haute tension doivent toujours être mises à la masse.

Ne touchez pas les connectiques sans que l'équipement soit éteint et que la capacité à la fois de la charge et de l'alimentation soient déchargées.

Prévoyez 5 minutes pour la décharge de la capacité interne de l'alimentation.

Ne vous mettez pas à la masse, ou ne travaillez pas sous conditions mouillées ou humides.



## CONSIGNES DE SÉCURITÉ EN CAS DE REPARATION

La maintenance peut nécessiter l'enlèvement du couvercle lorsque l'alimentation est encore allumée.

Les réparations doivent être effectuées par une personne qualifiée et connaissant les risques électriques.

Dans le manuel, les notes marquées « **WARNING** » attire l'attention sur les risques lors de la manipulation de ces équipements, qui peuvent entraîner de possibles blessures voire la mort.

Dans le manuel, les notes marquées « **CAUTION** » indiquent les procédures qui doivent être suivies afin d'éviter d'éventuels dommages sur l'équipement.

## IMPORTANTI PRECAUZIONI DI SICUREZZA

### SICUREZZA

QUESTO ALIMENTATORE GENERA TENSIONI CHE SONO PERICOLOSE E POTREBBERO ESSERE MORTALI.  
PONI ESTREMA CAUTELA QUANDO OPERI CON QUESTO APPARECCHIO.

Gli alimentatori ad alta tensione devono sempre essere collegati ad un impianto di terra.

Non toccare le connessioni a meno che l'apparecchio sia stato spento e la capacità interna del carico e dell'alimentatore stesso siano scariche.

Attendere cinque minuti per permettere la scarica della capacità interna dell'alimentatore ad alta tensione.

Non mettere a terra il proprio corpo oppure operare in ambienti bagnati o saturi d'umidità.



### SICUREZZA NELLA MANUTENZIONE.

Manutenzione potrebbe essere richiesta, rimuovendo la copertura con apparecchio acceso.

La manutenzione deve essere svolta da personale qualificato, coscio dei rischi elettrici.

Attenzione alle **AVVERTENZE** contenute nel manuale, che richiamano all'attenzione ai rischi quando si opera con tali unità e che potrebbero causare possibili ferite o morte.

Le note di **CAUTELA** contenute nel manuale, indicano le procedure da seguire per evitare possibili danni all'apparecchio.

To obtain information on Spellman's product warranty please visit our website at:

<http://www.spellmanhv.com/en/About/Warranty.aspx>

